

IEC Appliance Inlet C14 with Fuseholder 1- or 2-pole



See below:  
[Approvals and Compliances](#)

**Description**

- Panel mount :  
 Screw-on from front side
- Appliance Inlet , Protection class I
- Fuseholder for fuse-links 5 x 20 mm
- Meets the requirements of IEC 60335-1 for appliances in unattended use. This includes the enhanced requirements of glow wire tests acc. to IEC 60695-2-11 or -12 & -13.
- Solder / Quick Connect

**Characteristics**

- The fuse drawer "Fingergrip" can be removed by hand

**Weblinks**

[pdf data sheet](#), [html datasheet](#), [General Product Information](#), [Approvals](#), [Distributor-Stock-Check](#), [Accessories](#), [Detailed request for product](#)

**Technical Data**

|                                   |   |                                   |   |
|-----------------------------------|---|-----------------------------------|---|
| Ratings IEC                       | 10A / 250VAC; 50Hz  | Appliance inlet/-outlet           | C14 acc. to IEC 60320-1   |
| Ratings UL/CSA                    | 10A / 250VAC; 60Hz  |                                   | UL 498, CSA C22.2 no. 42 (for cold conditions) pin-temperature 70 °C, 10A, Protection Class I |
| Dielectric Strength               | > 1.5kVAC between L-N<br>> 3kVAC between L/N-PE<br>(1 min/50Hz)   | Fuseholder                        | 1-/2-pole, acc. to IEC 60127-6, for fuse-links 5 x 20mm                                       |
| Allowable Operation Temperature   | -25 °C to 70 °C   | Rated Power Acceptance @ Ta 23 °C | 5 x 20: 2.5W (1 pole)/ 1.6W (2-pole) per pole   |
| IP-Protection                     | front side IP20 acc. to IEC 60529                                 | Power Acceptance @ Ta > 23°C      | Admissible power acceptance at higher ambient temperature see derating curves                 |
| Protection against electric shock | Suitable for appliances with protection class I acc. to IEC 61140 |                                   |   |
| Terminal                          | Solder / Quick Connect  |                                   |   |
| Material: Housing                 | PA6, black / grey / white, UL 94V-0                               |                                   |   |

**Approvals and Compliances**

Detailed information on product approvals, code requirements, usage instructions and detailed test conditions can be looked up in [Details about Approvals](#)

SCHURTER products are designed for use in industrial environments. They have approvals from independent testing bodies according to national and international standards. Products with specific characteristics and requirements such as required in the automotive sector according to IATF 16949, medical technology according to ISO 13485 or in the aerospace industry can be offered exclusively with customer-specific, individual agreements by SCHURTER.

**Approvals**





The approval mark is used by the testing authorities to certify compliance with the safety requirements placed on electronic products.

Approval Reference Type: 1062

| Approval Logo | Certificates                    | Certification Body | Description                              |
|---------------|---------------------------------|--------------------|--|
|               | <a href="#">SEMKO Approvals</a> | SEMKO              | Certificate Number: SE/09137-1A          |
|               | <a href="#">UL Approvals</a>    | UL                 | UR File Number: E93617                   |
|               | <a href="#">CCC Approvals</a>   | CCC                | CCC Certificate Number: 2020180204016732 |



## Product standards

Product standards that are referenced

| Organization   | Design                | Standard         | Description   |
|--|-----------------------|------------------|---|
|  | Designed according to | IEC 60320-1      | Appliance couplers for household and similar general purposes         |
|  | Designed according to | IEC 60127-6      | Miniature fuses. Part 6. Fuse-holders for miniature fuse-links        |
|  | Designed according to | IEC 61058-1      | Switches for appliances. Part 1. General requirements                 |
|  | Designed according to | UL 498           | Standard for Attachment Plugs and Receptacles                         |
|  | Designed according to | CSA C22.2 no. 42 | General Use Receptacles, Attachment Plugs, and Similar Wiring Devices |







## Application standards

Application standards where the product can be used

| Organization   | Design                         | Standard       | Description  |
|--|--------------------------------|----------------|--|
|  | Suitable for applications acc. | IEC/UL 62368-1 | Audio/video, information and communication technology equipment - Part 1: Safety requirements  |
|  | Suitable for applications acc. | IEC 60335-1    | Safety of electrical appliances for household and similar purposes. Meets the requirements for appliances in unattended use. This includes the enhanced requirements of glow wire tests acc. to IEC 60695-2-11 or -12 & -13. |

## Compliances

The product complies with following Guide Lines

| Identification   | Details  | Initiator   | Description   |
|--|--|-------------|---|
|   | <a href="#">CE declaration of conformity</a>   | SCHURTER AG | The CE marking declares that the product complies with the applicable requirements laid down in the harmonisation of Community legislation on its affixing in accordance with EU Regulation 765/2008. |
|  | <a href="#">UKCA declaration of conformity</a> | SCHURTER AG | The UKCA marking declares that the product complies with the applicable requirements laid down in the British Amendment of Regulation (EC) 765/2008.  |
|  | RoHS   | SCHURTER AG | Directive RoHS 2011/65/EU, Amendment (EU) 2015/863  |
|  | China RoHS                                     | SCHURTER AG | The law SJ / T 11363-2006 (China RoHS) has been in force since 1 March 2007. It is similar to the EU directive RoHS.  |
|  | REACH  | SCHURTER AG | On 1 June 2007, Regulation (EC) No 1907/2006 on the Registration, Evaluation, Authorization and Restriction of Chemicals 1 (abbreviated as "REACH") entered into force.                               |
|  | White Paper Glow wire test                     | SCHURTER AG | Meets the requirements of IEC 60335-1 for appliances in unattended use. This includes the enhanced requirements of glow wire tests acc. to IEC 60695-2-11 or -12 & -13.                               |

Dimensions [mm]

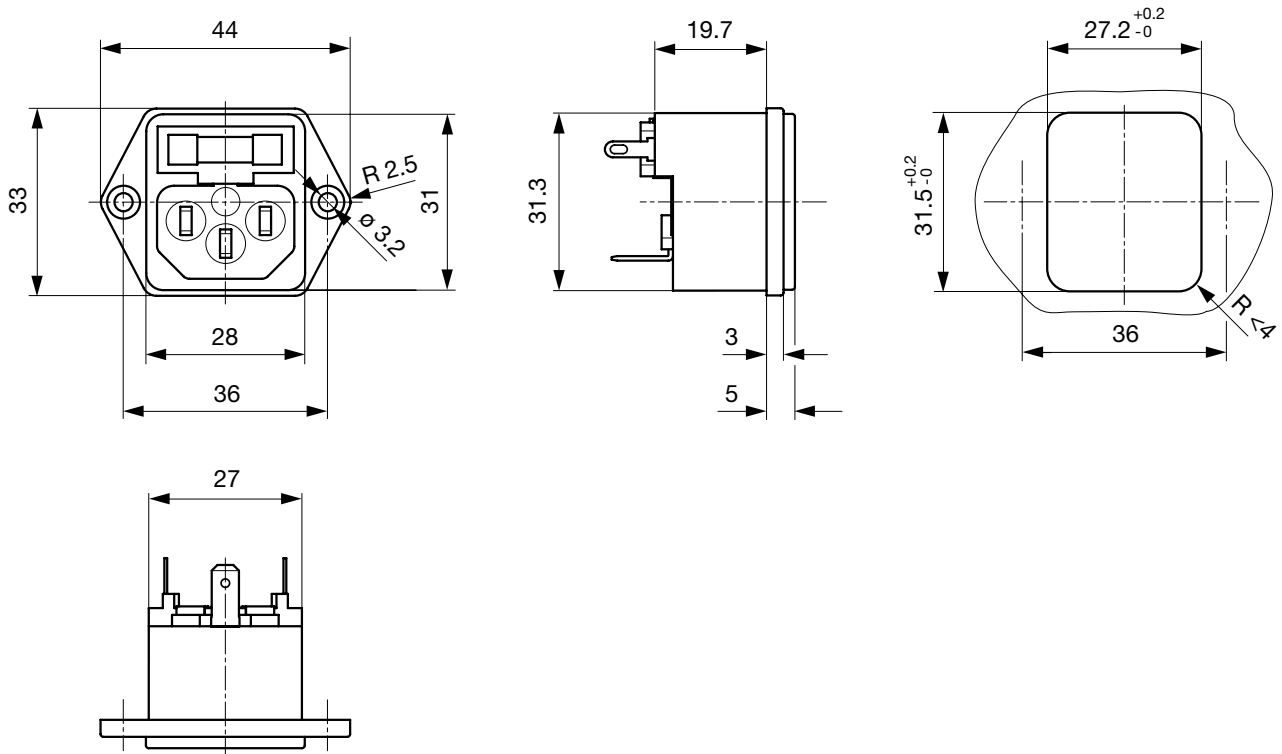

Length of the terminal please find at the order code configuration table

Derating Curves

Fuses  
 5 x 20 mm (1-pole)

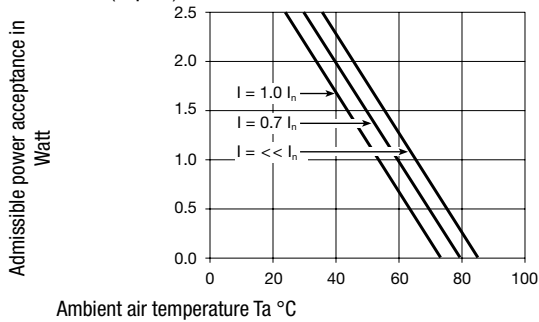

2-pole

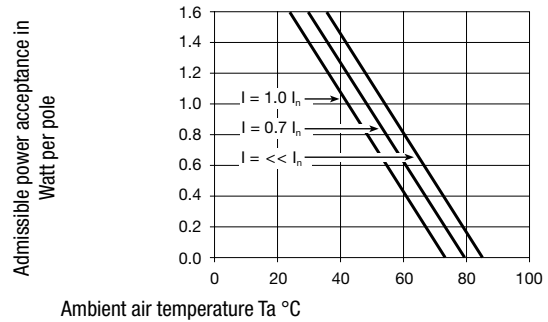

Config. Code

1062 - H - ABCN - D - EGO

The characters are placeholders for the correspondingly keys of selections from the key tables.

1062 - H - ABCN - D - EGO = Type

| Type               | Configuration key |
|--------------------|-------------------|
| protection class I | X                 |

1062 - H - ABCN - D - EGO = Terminals

| Terminal L                | Configuration key |
|---------------------------|-------------------|
| connection to fuse holder | B                 |

1062 - H - ABCN - D - EGO = Terminals

| Terminal N                         | Configuration key |
|------------------------------------|-------------------|
| short solder terminal (L = 4.8 mm) | 2                 |
| long solder terminal (L = 8.5 mm)  | 3                 |
| Blade terminal (4.8 x 0.8 mm)      | 8                 |
| Blade terminal (6.3 x 0.8 mm)      | 9                 |
| connection to fuse holder          | B                 |

Symbols similar as in table A

1062 - H - ABCN - D - EGO = Terminals

| Terminal Ground                    | Configuration key |
|------------------------------------|-------------------|
| without terminal                   | 0                 |
| short solder terminal (L = 4.8 mm) | 2                 |
| long solder terminal (L = 8.5 mm)  | 3                 |
| Blade terminal (4.8 x 0.8 mm)      | 8                 |
| Blade terminal (6.3 x 0.8 mm)      | 9                 |

Symbols similar as in table A

### 1062 - H - A B C N - D - E G O = Terminal Fuseholder

| Terminal Fuseholder | Configuration key |
|---------------------|-------------------|
| solder terminal     | 1                 |

### 1062 - H - A B C N - D - E G O = Color

| Color | Configuration key |
|-------|-------------------|
| Black | A                 |
| Grey  | B                 |
| White | D                 |

### 1062 - H - A B C N - D - E G O = Style

| Style                         | Configuration key |
|-------------------------------|-------------------|
| flange with countersunk holes | 1                 |
| flange with through holes     | 2                 |

### 1062 - H - A B C N - D - E G O = Dimension S

| Dimension "S" | Configuration key |
|---------------|-------------------|
| 00            |                   |

The dimension "S" is displayed in (1/10 mm). This information is also valid for the order code

### 1062 - H - A B C N - D - E G O = Features

| Features   | Configuration key |
|--|-------------------|
| dead cover   | 1                 |
| holder for 1 or 2 fuses (text legible, when inlet on top)    | 4                 |
| holder for 1 or 2 fuses (text legible, when inlet on bottom) | 5                 |

## All Variants

| Connector          |                           |                               |                                    |       |                               | Fuseholder  |                 | Config. Code       | Order Number |
|--------------------|---------------------------|-------------------------------|------------------------------------|-------|-------------------------------|---|-----------------|--------------------|--------------|
| Type               | Terminal L                | Terminal N                    | Terminal Ground                    | Color | Style                         | Marking   | Number of Poles |                    |              |
| protection class I | connection to fuse holder | Blade terminal (4.8 x 0.8 mm) | Blade terminal (4.8 x 0.8 mm)      | Black | flange with countersunk holes | holder for 1 or 2 fuses (text legible, when inlet on top) | 1-pole          | 1062-X-B881-A-1004 | 4304.6013    |
| protection class I | connection to fuse holder | Blade terminal (6.3 x 0.8 mm) | Blade terminal (6.3 x 0.8 mm)      | Black | flange with countersunk holes | holder for 1 or 2 fuses (text legible, when inlet on top) | 1-pole          | 1062-X-B991-A-1004 | 4304.6014    |
| protection class I | connection to fuse holder | connection to fuse holder     | short solder terminal (L = 4.8 mm) | Black | flange with countersunk holes | holder for 1 or 2 fuses (text legible, when inlet on top) | 2-pole          | 1062-X-BB21-A-1004 | 4304.6015    |
| protection class I | connection to fuse holder | connection to fuse holder     | Blade terminal (4.8 x 0.8 mm)      | Black | flange with countersunk holes | holder for 1 or 2 fuses (text legible, when inlet on top) | 2-pole          | 1062-X-BB81-A-1004 | 4304.6019    |
| protection class I | connection to fuse holder | connection to fuse holder     | Blade terminal (6.3 x 0.8 mm)      | Black | flange with countersunk holes | holder for 1 or 2 fuses (text legible, when inlet on top) | 2-pole          | 1062-X-BB91-A-1004 | 4304.6020    |

The listed variants should be available from stock. Other versions on request [www.schurter.com/contact](http://www.schurter.com/contact)

 Most Popular.

Availability for all products can be searched real-time: <https://www.schurter.com/en/info-center/support-tools/stock-check-distributors>

## Packaging unit

50 Pcs

**Accessories**

**Description**

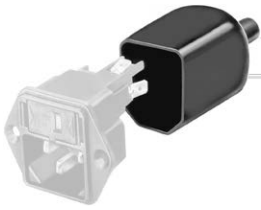

Assorted\_Covers  
Rear Cover



RC320  
Rear Cover for Power Entry Module

**Mating Outlets/Connectors**

**Category / Description**

[Appliance Outlet Overview complete](#)



|  |      |
|--|------|
| 4787, Mounting: Screw-on mounting, Appliance Outlet: IEC Solder terminals, 10 A, Suitable for appliances with protection class I     | 4787 |
| 4788, Mounting: Snap-in version, Appliance Outlet: IEC Solder / Quick Connect, 10 A, Suitable for appliances with protection class I | 4788 |
| IEC Appliance Outlet F or H, Screw-on Mounting, Front Side, Solder, PCB or Quick-connect Terminal                                    | 5091 |

[Connector Overview complete](#)



|   |         |
|---|---------|
| 4782 Mounting: Power Cord, 3 x 1 mm <sup>2</sup> / 3 x 18 AWG, Cable, Connector: IEC C13    | 4782    |
| 4785 Mounting: Power Cord, 3 x 1 mm <sup>2</sup> / 3 x 18 AWG, Cable, Connector: IEC C13    | 4785    |
| 4300-06 Mounting: Power Cord, 3 x 1 mm <sup>2</sup> / 3 x 18 AWG, Cable, Connector: IEC C13 | 4300-06 |
| 4781 Mounting: Power Cord, Cable, Connector: IEC C15  | 4781    |
| 4784 Mounting: Power Cord, 3 x 1 mm <sup>2</sup> / 3 x 18 AWG, Cable, Connector: IEC C15    | 4784    |

[Interconnection Cord Overview complete](#)



|  |           |
|--|-----------|
| Cord Sets 10 A, Interconnection, 2.0 m, IEC H05VV-F3G1.0, black                | 6007.0204 |
| Cord Sets 10 A, Interconnection, 1.0 m, Connector IEC C13, H05VV-F3G1.0, black | 6007.0212 |
| Cord Sets 10 A, Interconnection, 2.0 m, Connector IEC C13, H05VV-F3G1.0, black | 6007.0214 |

[Power Supply Cord Overview complete](#)



|  |           |
|--|-----------|
| Cord Sets 10 A, Europlug, 2.5 m, Connector IEC C13, H05VV-F3G1.0, black          | 6004.0215 |
| Cord Sets 10 A, Europlug, 2.5 m, Connector IEC C13, H05VV-F3G1.0, black          | 6003.0215 |
| Cord Sets 10 A, uninsulated wires, 2.0 m, Connector IEC C13, H05VV-F3G1.0, black | 6000.0224 |
| Cord Sets 10 A, uninsulated wires, 2.0 m, Connector IEC C13, H05VV-F3G1.0, black | 6000.0214 |
| Cord Sets 10 A, United Kingdom, 2.5 m, Connector IEC C13, H05VV-F3G1.0, black    | 6044.0215 |

...

Category / Description



[Power Supply or Interconnection Cord Overview complete](#)

Cord Sets 10 A, United Kingdom, 2.0 m, Connector IEC H05VV-F3G1.0, black

6044.0204

Mating Outlets/Connectors shuttered



[Power Cord Overview complete](#)

VAC17KS, V-Lock cord retaining, diverse m, Connector IEC C17, diverse, black / grey / white

VAC17KS