

IEC Appliance Inlet C14 or C18 with Fuseholder 1- or 2-pole



See below:
[Approvals and Compliances](#)

Description

- Panel mount :
 Snap-in version , front side Appliance Inlet , Protection class I , Fuseholder for fuse-links 5 x 20 mm
- Meets the requirements of IEC 60335-1 for appliances in unattended use. This includes the enhanced requirements of glow wire tests acc. to IEC 60695-2-11 or -12 &-13.
- Solder / Quick Connect

Characteristics

- The fuse drawer "Fingerrip" can be removed by hand

References

Weblinks
[pdf data sheet](#), [html datasheet](#), [General Product Information](#), [Approvals](#), [Distributor-Stock-Check](#), [Accessories](#), [Detailed request for product](#)

Technical Data

Ratings IEC	10A / 250VAC; 50Hz
Ratings UL/CSA	10A / 250VAC; 60Hz
Dielectric Strength	> 3kVAC between L-N > 1.5kVAC between L/N-PE (1 min/50Hz)
Allowable Operation Temperature	-25 °C to 70 °C
IP-Protection	front side IP20 acc. to IEC 60529
Protection against electric shock	Suitable for appliances with protection class I or II acc. to IEC 61140
Terminal	Solder / Quick Connect
Panel Thickness S	Snap-in 1.0 - 2.5 mm
Material: Housing	PA6, black / grey / white, UL 94V-0

Appliance inlet/-outlet	C14 / C18 acc. to IEC 60320-1 UL 498, CSA C22.2 no. 42 (for cold conditions) pin-temperature 70 °C, 10A, Protection Class I or II
Fuseholder	1-/2-pole, acc. to IEC 60127-6, for fuse-links 5 x 20mm
Power Acceptance @ Ta > 23°C	Admissible power acceptance at higher ambient temperature see derating curves

Approvals and Compliances

Detailed information on product approvals, code requirements, usage instructions and detailed test conditions can be looked up in [Details about Approvals](#)

SCHURTER products are designed for use in industrial environments. They have approvals from independent testing bodies according to national and international standards. Products with specific characteristics and requirements such as required in the automotive sector according to IATF 16949, medical technology according to ISO 13485 or in the aerospace industry can be offered exclusively with customer-specific, individual agreements by SCHURTER.

Approvals





The approval mark is used by the testing authorities to certify compliance with the safety requirements placed on electronic products.

Approval Reference Type: 1064

Approval Logo	Certificates	Certification Body	Description
	SEMKO Approvals	SEMKO	Certificate Number: SE/09137-1A
	UL Approvals	UL	UR File Number: E93617



Product standards

Product standards that are referenced

Organization	Design	Standard	Description
	Designed according to	IEC 60320-1	Appliance couplers for household and similar general purposes
	Designed according to	IEC 60127-6	Miniature fuses. Part 6. Fuse-holders for miniature fuse-links
	Designed according to	IEC 61058-1	Switches for appliances. Part 1. General requirements
	Designed according to	UL 498	Standard for Attachment Plugs and Receptacles
	Designed according to	CSA C22.2 no. 42	General Use Receptacles, Attachment Plugs, and Similar Wiring Devices







Application standards

Application standards where the product can be used

Organization	Design	Standard	Description
	Suitable for applications acc.	IEC/UL 62368-1	Audio/video, information and communication technology equipment - Part 1: Safety requirements
	Suitable for applications acc.	IEC 60335-1	Safety of electrical appliances for household and similar purposes. Meets the requirements for appliances in unattended use. This includes the enhanced requirements of glow wire tests acc. to IEC 60695-2-11 or -12 & -13.

Compliances

The product complies with following Guide Lines

Identification	Details	Initiator	Description
	CE declaration of conformity	SCHURTER AG	The CE marking declares that the product complies with the applicable requirements laid down in the harmonisation of Community legislation on its affixing in accordance with EU Regulation 765/2008.
	UKCA declaration of conformity	SCHURTER AG	The UKCA marking declares that the product complies with the applicable requirements laid down in the British Amendment of Regulation (EC) 765/2008.
	RoHS	SCHURTER AG	Directive RoHS 2011/65/EU, Amendment (EU) 2015/863
	China RoHS	SCHURTER AG	The law SJ / T 11363-2006 (China RoHS) has been in force since 1 March 2007. It is similar to the EU directive RoHS.
	REACH	SCHURTER AG	On 1 June 2007, Regulation (EC) No 1907/2006 on the Registration, Evaluation, Authorization and Restriction of Chemicals 1 (abbreviated as "REACH") entered into force.
	White Paper Glow wire test	SCHURTER AG	Meets the requirements of IEC 60335-1 for appliances in unattended use. This includes the enhanced requirements of glow wire tests acc. to IEC 60695-2-11 or -12 & -13.

Dimensions [mm]

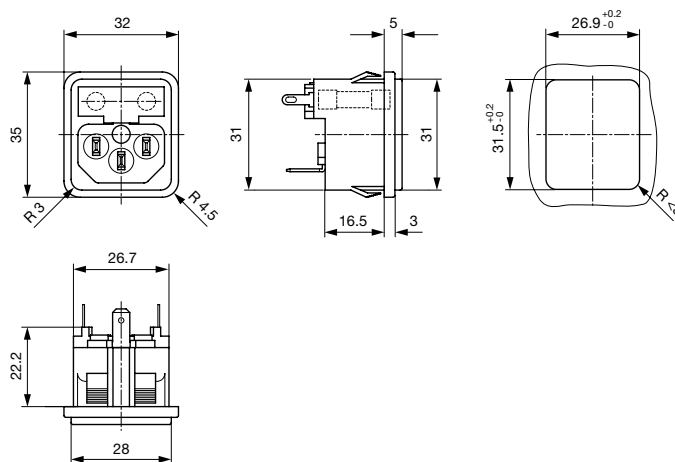

Length of the terminal please find at the order code configuration table

Derating Curves

Fuses
 5 x 20 mm (1-pole)

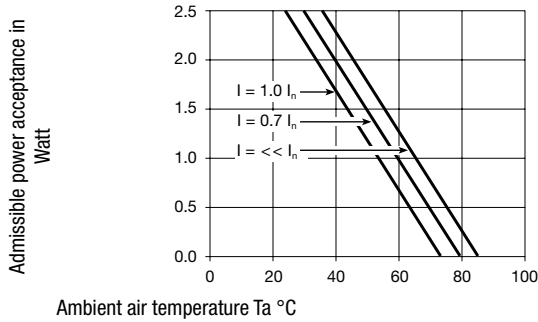

2-pole

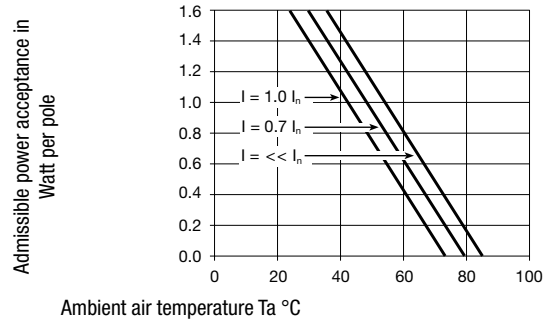

Config. Code

1064 - H - A B C N - D - E G O

The characters are placeholders for the correspondingly keys of selections from the key tables.





1064 - H - A B C N - D - E G O = Type

Type	Configuration key
protection class II	B
protection class I	X

Terminal Ground	Configuration key
short solder terminal (L = 4.8 mm)	2
long solder terminal (L = 8.5 mm)	3
Blade terminal (4.8 x 0.8 mm)	8
Blade terminal (6.3 x 0.8 mm)	9

Symbols similar as in table A

1064 - H - A B C N - D - E G O = Terminals

Terminal L	Configuration key
short solder terminal (L = 4.8 mm) 	2
long solder terminal (L = 8.5 mm) 	3
Blade terminal (4.8 x 0.8 mm) 	8
Blade terminal (6.3 x 0.8 mm) 	9
connection to fuse holder	B

1064 - H - A B C N - D - E G O = Terminal Fuseholder

Terminal Fuseholder	Configuration key
solder terminal	1

1064 - H - A B C N - D - E G O = Color

Color	Configuration key
Black	A
Grey	B
White	D

1064 - H - A B C N - D - E G O = Style

Style	Configuration key
snap-in standard type	3

1064 - H - A B C N - D - E G O = Dimension S

Dimension "S"	Configuration key
00	

The dimension "S" is displayed in (1/10 mm). This information is also valid for the order code

1064 - H - A B C N - D - E G O = Features

Features	Configuration key
dead cover	1

1064 - H - A B C N - D - E G O = Terminals

Terminal N	Configuration key
short solder terminal (L = 4.8 mm)	2
long solder terminal (L = 8.5 mm)	3
Blade terminal (4.8 x 0.8 mm)	8
Blade terminal (6.3 x 0.8 mm)	9
connection to fuse holder	B

Symbols similar as in table A

1064 - H - A B C N - D - E G O = Terminals

Terminal Ground	Configuration key
without terminal	0

Symbols similar as in table A

Features	Configuration key	Features	Configuration key
holder for 1 or 2 fuses (text legible, when inlet on top)	4	holder for 1 or 2 fuses (text legible, when inlet on bottom)	5

All Variants

Connector						Fuseholder			
Type	Terminal L	Terminal N	Terminal Ground	Color	Style	Marking	Number of Poles	Config. Code	Order Number
protection class I	connection to fuse holder	short solder terminal (L = 4.8 mm)	short solder terminal (L = 4.8 mm)	Black	snap-in standard type	holder for 1 or 2 fuses (text legible, when inlet on top)	1-pole	1064-X-B221-A-3004	4304.6025
protection class I	connection to fuse holder	Blade terminal (4.8 x 0.8 mm)	Blade terminal (4.8 x 0.8 mm)	Black	snap-in standard type	holder for 1 or 2 fuses (text legible, when inlet on top)	1-pole	1064-X-B881-A-3004	4304.6026
protection class I	connection to fuse holder	Blade terminal (6.3 x 0.8 mm)	Blade terminal (6.3 x 0.8 mm)	Black	snap-in standard type	holder for 1 or 2 fuses (text legible, when inlet on top)	1-pole	1064-X-B991-A-3004	4304.6027
protection class I	connection to fuse holder	connection to fuse holder	short solder terminal (L = 4.8 mm)	Black	snap-in standard type	holder for 1 or 2 fuses (text legible, when inlet on top)	2-pole	1064-X-BB21-A-3004	4304.6028
protection class I	connection to fuse holder	connection to fuse holder	short solder terminal (L = 4.8 mm)	Black	snap-in standard type	holder for 1 or 2 fuses (text legible, when inlet on bottom)	2-pole	1064-X-BB21-A-3005	4304.6029
protection class I	connection to fuse holder	connection to fuse holder	Blade terminal (4.8 x 0.8 mm)	Black	snap-in standard type	holder for 1 or 2 fuses (text legible, when inlet on top)	2-pole	1064-X-BB81-A-3004	4304.6030
protection class I	connection to fuse holder	connection to fuse holder	Blade terminal (6.3 x 0.8 mm)	Black	snap-in standard type	holder for 1 or 2 fuses (text legible, when inlet on top)	2-pole	1064-X-BB91-A-3004	4304.6031
protection class I	connection to fuse holder	connection to fuse holder	short solder terminal (L = 4.8 mm)	White	snap-in standard type	holder for 1 or 2 fuses (text legible, when inlet on top)	2-pole	1064-X-BB21-D-3004	4304.6129

The listed variants should be available from stock. Other versions on request www.schurter.com/contact

Most Popular.

Availability for all products can be searched real-time: <https://www.schurter.com/en/info-center/support-tools/stock-check-distributors>

Packaging unit

50 Pcs

Accessories

Description

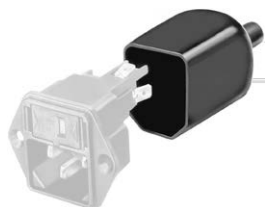

Assorted_Covers
Rear Cover



RC320
Rear Cover for Power Entry Module

Mating Outlets/Connectors

Category / Description

[Appliance Outlet Overview complete](#)



4787, Mounting: Screw-on mounting, Appliance Outlet: IEC Solder terminals, 10 A, Suitable for appliances with protection class I	4787
4788, Mounting: Snap-in version, Appliance Outlet: IEC Solder / Quick Connect, 10 A, Suitable for appliances with protection class I	4788
IEC Appliance Outlet F or H, Screw-on Mounting, Front Side, Solder, PCB or Quick-connect Terminal	5091

[Connector Overview complete](#)



4782 Mounting: Power Cord, 3 x 1 mm ² / 3 x 18 AWG, Cable, Connector: IEC C13	4782
4785 Mounting: Power Cord, 3 x 1 mm ² / 3 x 18 AWG, Cable, Connector: IEC C13	4785
4300-06 Mounting: Power Cord, 3 x 1 mm ² / 3 x 18 AWG, Cable, Connector: IEC C13	4300-06
4781 Mounting: Power Cord, Cable, Connector: IEC C15	4781
4784 Mounting: Power Cord, 3 x 1 mm ² / 3 x 18 AWG, Cable, Connector: IEC C15	4784