

Strip Block for Snap-in Mounting with 2 IEC Appliance Outlets



type J



70° C

See below:

[Approvals and Compliances](#)

Description

- Panel mount
- Snap-in version front side
- Module of 2 outlets
- Pin temperature 70 °C , Protection class I
- QC 6.3 x 0.8 mm

Characteristics

- Suitable for use in equipment according to IEC/UL 62368-1

Other versions on request

- Other panel thicknesses
- Other terminal combinations

Weblinks

[pdf data sheet](#), [html datasheet](#), [General Product Information](#), [Approvals](#), [Distributor-Stock-Check](#), [Accessories](#), [Detailed request for product](#)

Technical Data

Ratings IEC	16A / 250VAC; 50/60Hz
Ratings UL/CSA	20A / 250VAC; 50/60Hz
Dielectric Strength	> 2 kVAC between L-N > 3 kVAC between L/N-PE (1 min/50Hz)
Allowable Operation Temperature	-25 °C to 70 °C
IP-Protection	front side IP20 acc. to IEC 60529
Protection against electric shock	Suitable for appliances with protection class I acc. to IEC 61140
Terminal	Quick connect terminals
Panel Thickness S	1.5 mm tolerance +/- 0.1
Material: Housing	Thermoplastic, black / grey / white

Appliance inlet/-outlet	J acc. to IEC 60320-1-11 UL 60320-1 CSA C22.2 no. 42 (for cold conditions) pin-temperature 70 °C, 16A, Protection Class I
-------------------------	--

Approvals and Compliances

Detailed information on product approvals, code requirements, usage instructions and detailed test conditions can be looked up in [Details about Approvals](#)

SCHURTER products are designed for use in industrial environments. They have approvals from independent testing bodies according to national and international standards. Products with specific characteristics and requirements such as required in the automotive sector according to IATF 16949, medical technology according to ISO 13485 or in the aerospace industry can be offered exclusively with customer-specific, individual agreements by SCHURTER.

Approvals



The approval mark is used by the testing authorities to certify compliance with the safety requirements placed on electronic products.

Approval Reference Type: 4770

Approval Logo	Certificates	Certification Body	Description
	VDE Approvals	VDE	Certificate Number: 40061522
	UL Approvals	UL	UR File Number: E502078
	CCC Approvals	CCC	CCC Certificate Number: 2026180204079537

Product standards

Product standards that are referenced

Organization	Design	Standard	Description
	Designed according to	IEC 60320-1-11	Appliance couplers for household and similar general purposes
	Designed according to	UL 60320-1	Standard for Attachment Plugs and Receptacles
	Designed according to	CSA C22.2 no. 42	General Use Receptacles, Attachment Plugs, and Similar Wiring Devices





Application standards

Application standards where the product can be used

Organization	Design	Standard	Description
	Suitable for applications acc.	IEC/UL 62368-1	Audio/video, information and communication technology equipment - Part 1: Safety requirements

Compliances

The product complies with following Guide Lines

Identification	Details	Initiator	Description
	CE declaration of conformity	SCHURTER AG	The CE marking declares that the product complies with the applicable requirements laid down in the harmonisation of Community legislation on its affixing in accordance with EU Regulation 765/2008.
	UKCA declaration of conformity	SCHURTER AG	The UKCA marking declares that the product complies with the applicable requirements laid down in the British Amendment of Regulation (EC) 765/2008.
	RoHS	SCHURTER AG	Directive RoHS 2011/65/EU, Amendment (EU) 2015/863
	China RoHS	SCHURTER AG	The law SJ / T 11363-2006 (China RoHS) has been in force since 1 March 2007. It is similar to the EU directive RoHS.
	REACH	SCHURTER AG	On 1 June 2007, Regulation (EC) No 1907/2006 on the Registration, Evaluation, Authorization and Restriction of Chemicals 1 (abbreviated as "REACH") entered into force.

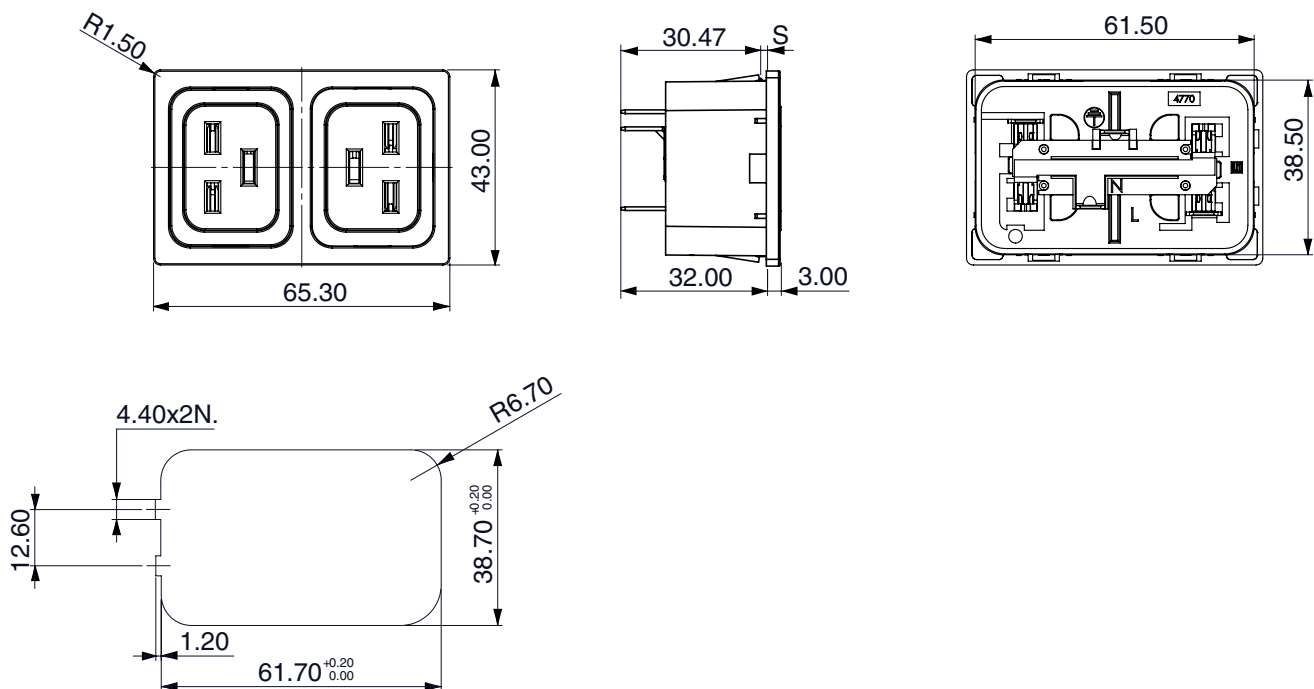
Dimensions [mm]

Variants

Color	Panel mounting	Panel Thickness s [mm]	Terminal type	Hard-Wired Bus	Order Number
black	Snap-in	1.5	QC 6.3 x 0.8 mm	L/N/PE bussed	3-151-445
white	Snap-in	1.5	QC 6.3 x 0.8 mm	L/N/PE bussed	3-151-446
grey	Snap-in	1.5	QC 6.3 x 0.8 mm	L/N/PE bussed	3-151-447

Availability for all products can be searched real-time: <https://www.schurter.com/en/info-center/support-tools/stock-check-distributors>

Packaging unit

60 Pcs

Mating Inlets/Plugs

Category / Description

[Plug Overview complete](#)



4796, Mounting: Power Cord, Cable, Plug: IEC I	4796
4789, Mounting: Power Cord, Screw, Plug: IEC I	4789
0922, Mounting: Power Cord, Wire connections 3 x (16-12AWG), Plug: IEC I	0922