

Plug, solder terminal, insulated, 2-pole, Audio Plug/Sockets, 2.5 mm



See below:

Approvals and Compliances

Description

- Solder :
for cable mounting
- Audio entrances and exits
- Data and Signal transfer
- Audio Plug: 2-pole , insulated , angled

References

Alternative: Housing shielded [4831.1200](#)

Weblinks

[pdf data sheet](#), [html datasheet](#), [General Product Information](#), [Distributor-Stock-Check](#), [Detailed request for product](#)

Technical Data

Diameter	2.5 mm	Allowable Operation Temperature	-20°C to 70°C
Number of Poles	2-pole	Terminal	solder terminal nickel-plated
Ratings DC	0.5 A / 30VDC	Housing	insulated
Ratings AC	0.5 A / 30 VAC	Style	angled
Dielectric Strength	500VDC	Lifetime	5000Insertions
Insulation Resistance	> 100 MΩ @ 500VDC		

Approvals and Compliances

Detailed information on product approvals, code requirements, usage instructions and detailed test conditions can be looked up in [Details about Approvals](#)

SCHURTER products are designed for use in industrial environments. They have approvals from independent testing bodies according to national and international standards. Products with specific characteristics and requirements such as required in the automotive sector according to IATF 16949, medical technology according to ISO 13485 or in the aerospace industry can be offered exclusively with customer-specific, individual agreements by SCHURTER.

Compliances

The product complies with following Guide Lines

Identification	Details	Initiator	Description
	RoHS	SCHURTER AG	Directive RoHS 2011/65/EU, Amendment (EU) 2015/863
	China RoHS	SCHURTER AG	The law SJ / T 11363-2006 (China RoHS) has been in force since 1 March 2007. It is similar to the EU directive RoHS.
	REACH	SCHURTER AG	On 1 June 2007, Regulation (EC) No 1907/2006 on the Registration, Evaluation, Authorization and Restriction of Chemicals 1 (abbreviated as "REACH") entered into force.

Dimensions [mm]

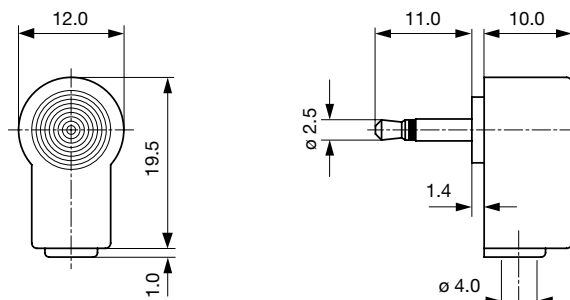

Cable diameter max. 4.0 mm

Variants

Product group	Diameter [mm]	Number of Poles	Terminal	Order Number
Audio Plug/Sockets	2.5	2-pole	solder terminal	4831.1220

Availability for all products can be searched real-time: <https://www.schurter.com/en/info-center/support-tools/stock-check-distributors>

Packaging unit	100 Pcs
-----------------------	---------

Mating Outlets/Connectors

Category / Description



[Audio Plug/Sockets Overview complete](#)

Socket, solder terminal, screened, 2-pole, Audio Plug/Sockets, 2.5 mm	4831.2200
Socket, PCB terminals, screened, 2-pole, Audio Plug/Sockets, 2.5 mm	4831.2220
Socket, PCB terminals, insulated, 2-pole, Audio Plug/Sockets, 2.5 mm	4831.2230
Line Socket, solder terminal, insulated, 2-pole, Audio Plug/Sockets, 2.5 mm	4831.3200