

2-stage filter for 3-phase systems with neutral conductor



See below:

**Approvals and Compliances**

**Description**

- Terminals for three phases, neutral conductor and ground

**Applications**

- Voltage rating 520 VAC for world wide acceptance
- Protection against interference voltage from the mains
- Especially designed for industrial applications such as: Frequency Converters, Stepper Motor Drives, UPS-Systems, Inverters

**References**

**Weblinks**

[pdf data sheet](#), [html datasheet](#), [General Product Information](#), [Approvals](#), [Distributor-Stock-Check](#), [Detailed request for product](#), [Microsite](#)

**Technical Data**

Rated Current	8 - 200 A
Rated voltage	300/520 VAC, 50/60 Hz
Approval for	8 - 200 A @ 50 (75) °C / 300/520 VAC; 50/60 Hz
Overload Current	1.5 x I <sub>r</sub> for 1 minute, per hour
Dielectric Strength	300/520 VAC: 2.25 kVDC between L-L 1.7 kVDC between L-N 2.75 kVDC between L-PE 2.75 kVDC between N-PE Test voltage 2 sec
Number of Filter Stages	2-stage
Weight	1.1 - 8.6 kg
Material: Housing	Metal
Sealing Compound	UL 94V-0

Mounting	Screw-on mounting on chassis
Terminal	Screw clamps
Operating Temperature	-25 °C to 100 °C
Climatic Category	25/100/21 acc. to IEC 60068-1
Degree of Protection	IP20 acc. to IEC 60529
Protection Class	Suitable for appliances with protection class I acc. to IEC 61140
MTBF	> 200'000h acc. to MIL-HB-217 F

**Approvals and Compliances**



Detailed information on product approvals, code requirements, usage instructions and detailed test conditions can be looked up in [Details about Approvals](#)

SCHURTER products are designed for use in industrial environments. They have approvals from independent testing bodies according to national and international standards. Products with specific characteristics and requirements such as required in the automotive sector according to IATF 16949, medical technology according to ISO 13485 or in the aerospace industry can be offered exclusively with customer-specific, individual agreements by SCHURTER.

**Approvals**



The approval mark is used by the testing authorities to certify compliance with the safety requirements placed on electronic products.

Approval Reference Type: FMBD NEO

Approval Logo	Certificates	Certification Body	Description
	<a href="#">VDE Approvals</a>	VDE	Certificate Number: 40031052
	<a href="#">UL Approvals</a>	UL	UR File Number: E72928

### Product standards

Product standards that are referenced

Organization	Design	Standard	Description
	Designed according to	IEC 60939	Passive filters for suppressing electromagnetic interference
	Designed according to	UL 1283	Passive filters for suppressing electromagnetic interference





### Application standards

Application standards where the product can be used

Organization	Design	Standard	Description
	Suitable for applications acc.	IEC/UL 62368-1	Audio/video, information and communication technology equipment - Part 1: Safety requirements

### Compliances

The product complies with following Guide Lines

Identification	Details	Initiator	Description
	<a href="#">CE declaration of conformity</a>	SCHURTER AG	The CE marking declares that the product complies with the applicable requirements laid down in the harmonisation of Community legislation on its affixing in accordance with EU Regulation 765/2008.
	<a href="#">UKCA declaration of conformity</a>	SCHURTER AG	The UKCA marking declares that the product complies with the applicable requirements laid down in the British Amendment of Regulation (EC) 765/2008.
	RoHS	SCHURTER AG	Directive RoHS 2011/65/EU, Amendment (EU) 2015/863
	China RoHS	SCHURTER AG	The law SJ / T 11363-2006 (China RoHS) has been in force since 1 March 2007. It is similar to the EU directive RoHS.
	REACH	SCHURTER AG	On 1 June 2007, Regulation (EC) No 1907/2006 on the Registration, Evaluation, Authorization and Restriction of Chemicals 1 (abbreviated as "REACH") entered into force.

### Dimension [mm]

Case 2A

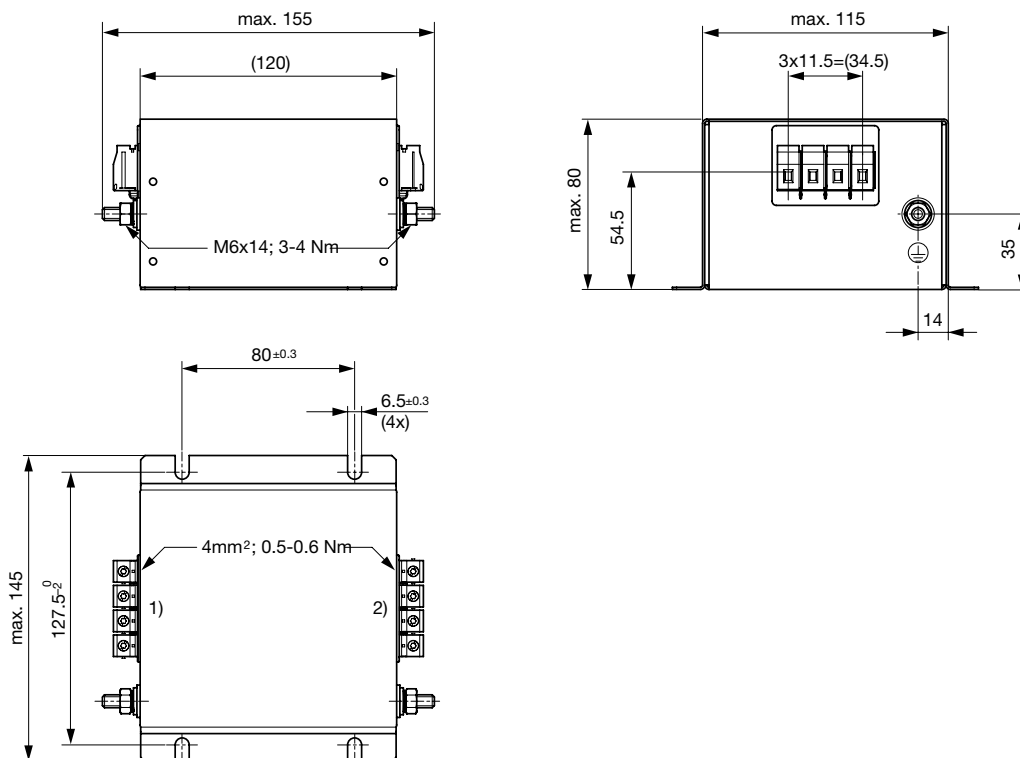

- 1) Line
- 2) Load

Case 2B

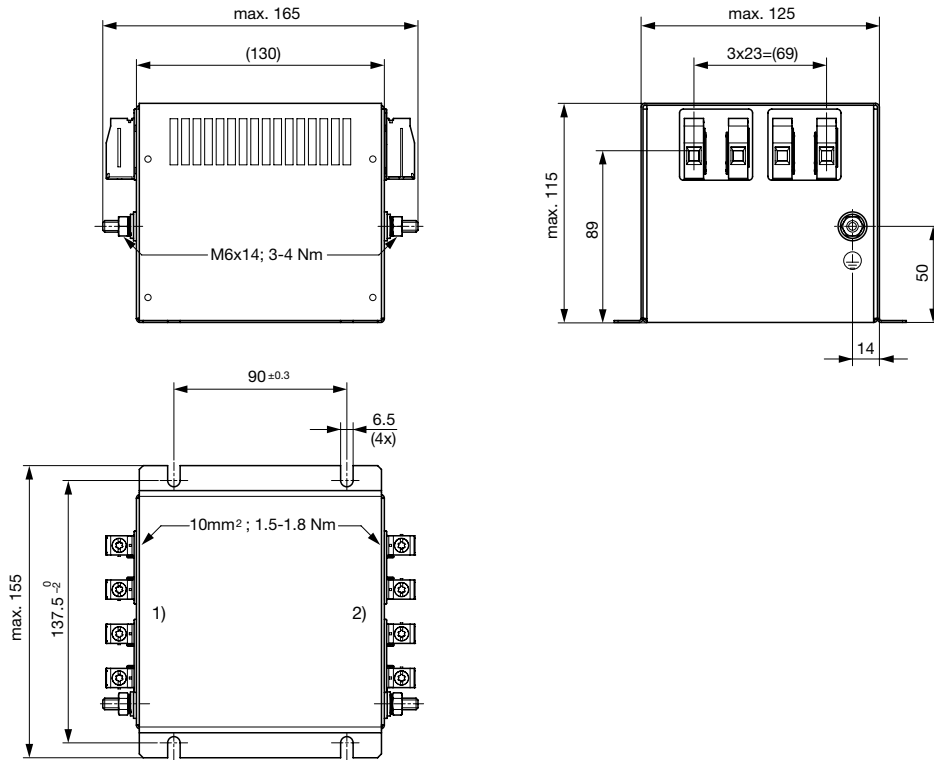

- 1) Line
  - 2) Load
- Case 2C

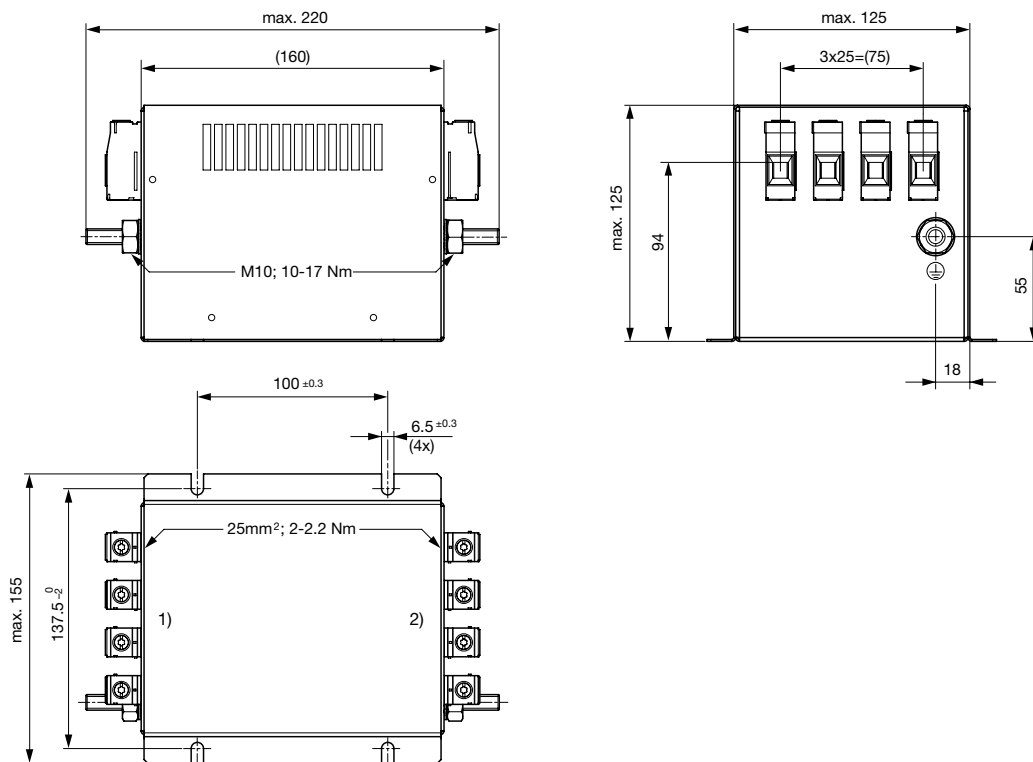

- 1) Line
- 2) Load

Case 2D

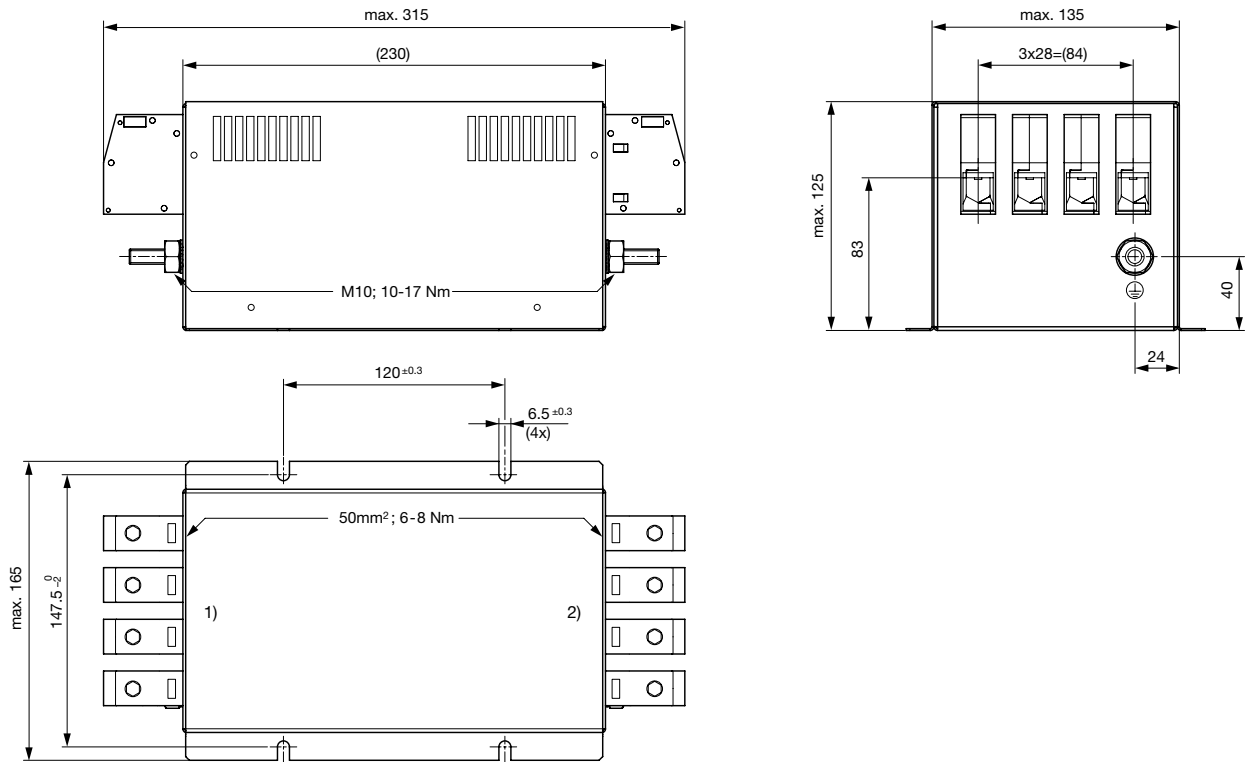

- 1) Line
- 2) Load

Case 2E

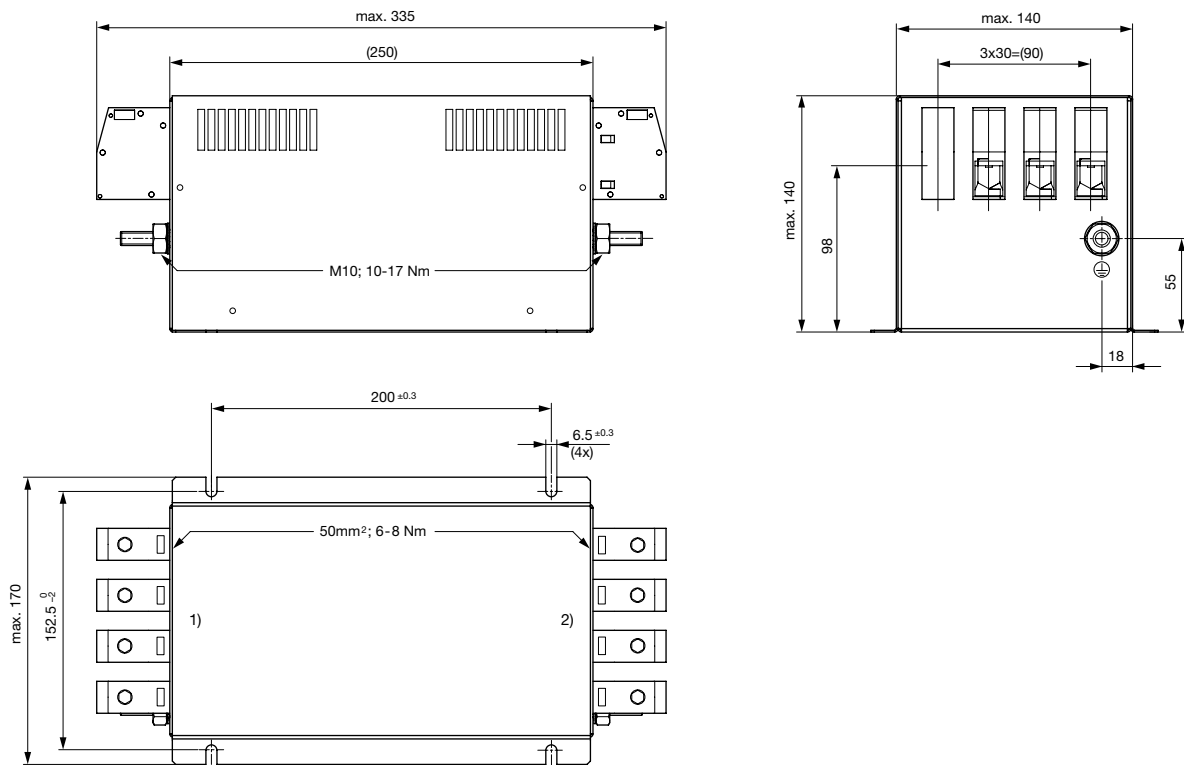

- 1) Line
- 2) Load

Case 2F

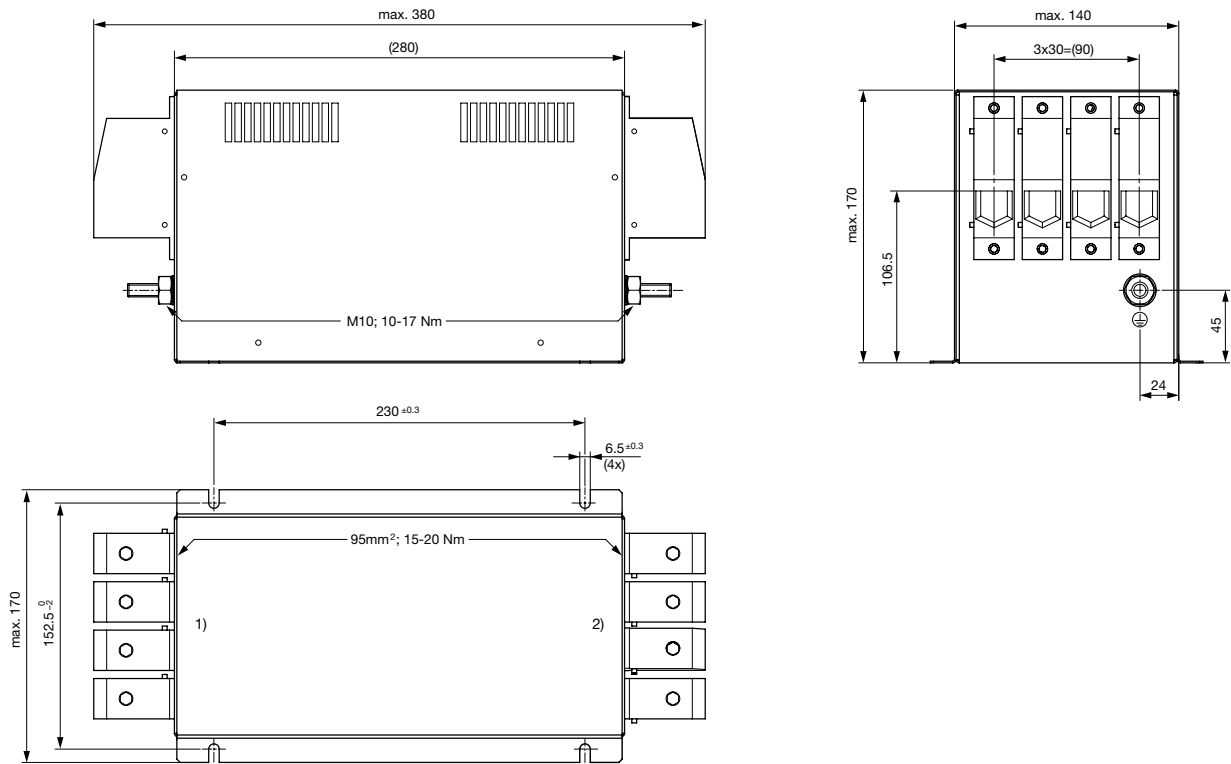

- 1) Line
- 2) Load

Technical data to the filter components

Rated Current @ Ta 50°C (75°C) [A]	L1 [mH]	L2 [μH]	C1 [μF]	C2 [μF]	C3 [μF]	R1 [MΩ]	R2 [MΩ]	R3 [MΩ]
16 (11)	1.3	12	2.2	2.2	0.05	-	1	2
8 (5)	2	4	2.2	2.2	0.05	-	1	2
25 (16)	1.6	12	4.7	4.7	0.05	1	1	2
36 (21)	1	12	4.7	4.7	0.05	1	1	2
64 (40)	0.7	7.5	4.7	4.7	0.05	1	1	2
80 (50)	0.6	9	8.2	8.2	0.05	1	1	2
120 (96)	0.6	9	13.6	13.6	0.05	0.5	0.5	2
160 (100)	0.4	9	13.6	13.6	0.05	0.5	0.5	2
200 (140)	0.3	9	13.6	13.6	0.05	0.5	0.5	2
8 (5)	2	4	2.2	2.2	3.4	-	1	2
16 (11)	1.3	12	2.2	2.2	3.4	-	1	2
25 (16)	1.6	12	4.7	4.7	3.4	1	1	2
36 (21)	1	12	4.7	4.7	3.4	1	1	2
64 (40)	0.7	7.5	4.7	4.7	3.4	1	1	2
80 (50)	0.6	9	8.2	8.2	3.4	1	1	2
120 (96)	0.6	9	13.6	13.6	3.4	0.5	0.5	2
160 (100)	0.4	9	13.6	13.6	3.4	0.5	0.5	2
200 (140)	0.3	9	13.6	13.6	3.4	0.5	0.5	2

Diagrams

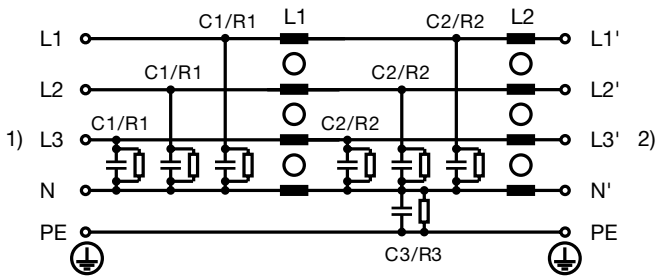

- 1) Line
- 2) Load

Derating Curves

Permissible Working Current as a Function of Ambient Temperature

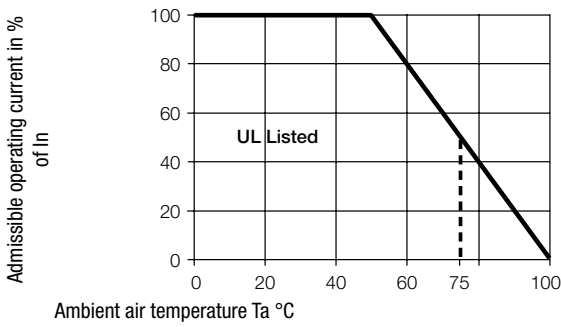

Attenuation Loss . . . 0.1/100Ω differential mode ..... 100/0.1Ω differential mode - - - 50Ω differential mode \_\_\_\_ 50Ω common mode  
 Industrial version

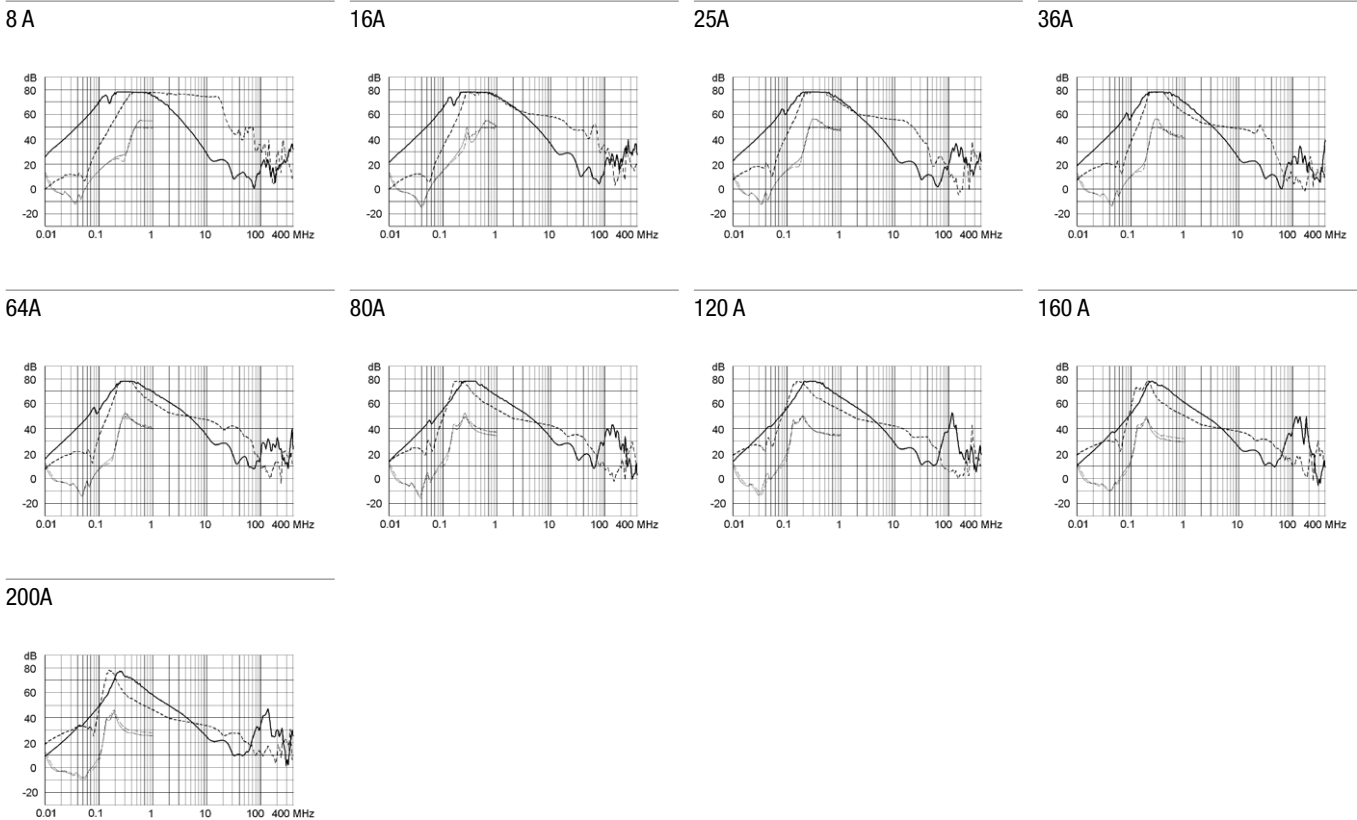

Low leakage current version

8 A

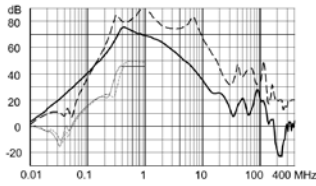

16 A

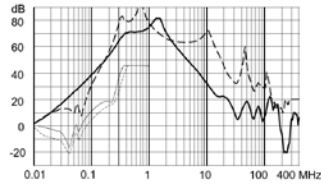

25 A

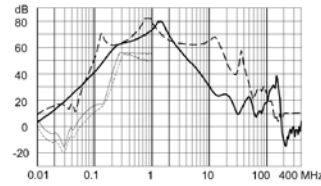

36 A

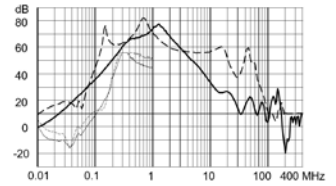

64 A

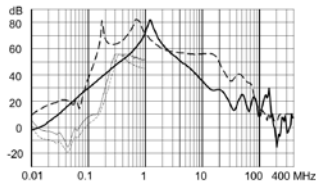

80 A

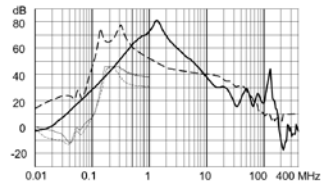

120 A

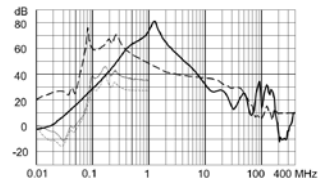

160 A

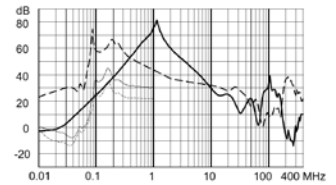

### All Variants

Rated Current @ Ta 50°C (75°C) [A]	Power Dissipation [W]	Contact Resistance [mΩ]	Leakage Current [mA] @ 440V, 60Hz 1)	Weight [kg]	Screw clamps [mm <sup>2</sup> ] 2)	Housing	Packaging unit [PCS]	Order Number
16 (11)	7	6.8	1	1.2 kg	4	2A	2	3-108-667
8 (5)	3.2	12.5	1	1.1 kg	4	2A	2	3-110-034
25 (16)	9.5	3.8	1	1.8 kg	10	2B	2	3-110-035
36 (21)	12.5	2.4	1	2 kg	10	2B	2	3-110-036
64 (40)	21.3	1.3	1	2.8 kg	25	2C	1	3-110-037
80 (50)	22.6	0.88	1	5.7 kg	50	2D	1	3-110-038
120 (96)	43.2	0.75	1	6.3 kg	50	2E	1	3-110-039
160 (100)	37.9	0.37	1	8 kg	95	2F	1	3-110-040
200 (140)	41.6	0.26	1	8.6 kg	95	2F	1	3-110-041
8 (5)	3.2	12.5	11.1	1.1 kg	4	2A	2	FMBD-B92A-0812
16 (11)	7	6.8	11.1	1.2 kg	4	2A	2	FMBD-B92A-1612
25 (16)	9.5	3.8	12.7	1.8 kg	10	2B	2	FMBD-B92B-2512
36 (21)	12.5	2.4	12.7	2 kg	10	2B	2	FMBD-B92B-3612
64 (40)	21.3	1.3	12.7	2.8 kg	25	2C	1	FMBD-B92C-6412
80 (50)	22.6	0.88	13.2	5.7 kg	50	2D	1	FMBD-B92D-8012
120 (96)	43.2	0.75	13.6	6.3 kg	50	2E	1	FMBD-B92E-J212
160 (100)	37.9	0.37	13.6	8 kg	95	2F	1	FMBD-B92F-J612
200 (140)	41.6	0.26	13.6	8.6 kg	95	2F	1	FMBD-B92F-K012

Availability for all products can be searched real-time: <https://www.schurter.com/en/info-center/support-tools/stock-check-distributors>

1) Leakage current according IEC 60939-1

2) Maximum conductor cross section (wire gauge) to be used; a comparative table for AWG and mm<sup>2</sup> values can be found in the general product information <https://www.schurter.com/en/FAQ#10>