

Compact 1-stage filter for 3-phase systems with neutral conductor



See below:

**Approvals and Compliances**

**Description**

- Quick-connect terminals 6.3 x 0.8 for three phases, neutral conductor and ground

**Applications**

- Especially designed for industrial applications such as: Frequency Converters, Stepper Motor Drives, UPS-Systems, Inverters  
 - Suitable for use in equipment according to IEC/UL 62368-1

**References**

We recommend for new applications the type [FMAD CP](#)

**Weblinks**

[pdf data sheet](#), [html datasheet](#), [General Product Information](#), [Approvals](#), [Distributor-Stock-Check](#), [Detailed request for product](#), [Microsite](#)

**Technical Data**

Rated Current	3 - 20A @ Ta 40 °C
Rated voltage	275/480 VAC, 50/60 Hz
Approval for	3 - 20A / 250/440 VAC; 50 Hz
Overload Current	1.5 x Ir for 1 minute, per hour
Leakage Current	industrial < 3 mA (440V / 50Hz)
Dielectric Strength	2.25 kVDC between L-L
	1.7 kVDC between L-N
	3 kVDC between L-PE
	2.7 kVDC between N-PE
	Test voltage 2 sec
Number of Filter Stages	1-stage
Weight	0.2 - 0.35 kg
Material: Housing	Metal
Sealing Compound	UL 94V-0

Mounting	Screw-on mounting on chassis, from top
Terminal	Quick connect terminals 6.3 x 0.8 mm
Operating Temperature	-25 °C to 100 °C
Climatic Category	25/100/21 acc. to IEC 60068-1
Degree of Protection	IP20 acc. to IEC 60529
Protection Class	Suitable for appliances with protection class I acc. to IEC 61140
MTBF	> 200'000h acc. to MIL-HB-217 F

**Approvals and Compliances**

Detailed information on product approvals, code requirements, usage instructions and detailed test conditions can be looked up in [Details about Approvals](#)

SCHURTER products are designed for use in industrial environments. They have approvals from independent testing bodies according to national and international standards. Products with specific characteristics and requirements such as required in the automotive sector according to IATF 16949, medical technology according to ISO 13485 or in the aerospace industry can be offered exclusively with customer-specific, individual agreements by SCHURTER.

**Approvals**

The approval mark is used by the testing authorities to certify compliance with the safety requirements placed on electronic products.

Approval Reference Type: FMW4

Approval Logo	Certificates	Certification Body	Description
	<a href="#">VDE Approvals</a>	VDE	Certificate Number: 40004673

**Product standards**

Product standards that are referenced

Organization	Design	Standard	Description
	Designed according to	IEC 60939	Passive filters for suppressing electromagnetic interference
	Designed according to	UL 1283	Passive filters for suppressing electromagnetic interference





### Application standards

Application standards where the product can be used

Organization	Design	Standard	Description
	Suitable for applications acc.	IEC/UL 62368-1	Audio/video, information and communication technology equipment - Part 1: Safety requirements

### Compliances

The product complies with following Guide Lines

Identification	Details	Initiator	Description
	<a href="#">CE declaration of conformity</a>	SCHURTER AG	The CE marking declares that the product complies with the applicable requirements laid down in the harmonisation of Community legislation on its affixing in accordance with EU Regulation 765/2008.
	RoHS	SCHURTER AG	Directive RoHS 2011/65/EU, Amendment (EU) 2015/863
	China RoHS	SCHURTER AG	The law SJ / T 11363-2006 (China RoHS) has been in force since 1 March 2007. It is similar to the EU directive RoHS.
	REACH	SCHURTER AG	On 1 June 2007, Regulation (EC) No 1907/2006 on the Registration, Evaluation, Authorization and Restriction of Chemicals 1 (abbreviated as "REACH") entered into force.

### Dimension [mm]

Case 47

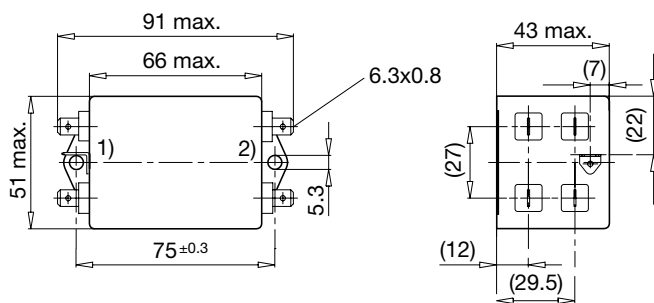

- 1) Line
- 2) Load

### Diagrams

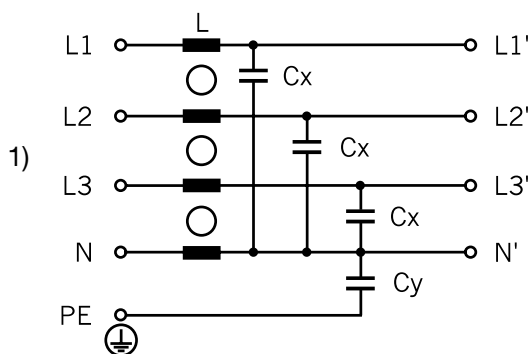

- 1) Line

**Attenuation Loss**

--- 50Ω differential mode    \_\_\_\_ 50Ω common mode

Standard version

3A (FMW-65-0001)

6A (FMW-65-0002)

10A (FMW-65-0003)

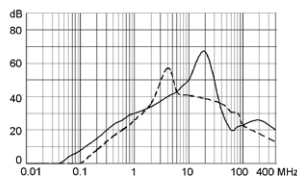
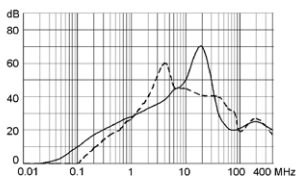
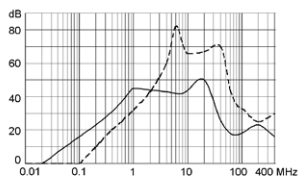

Industrial version

10A (FMW-65-0004)

20A (FMW-65-0005)

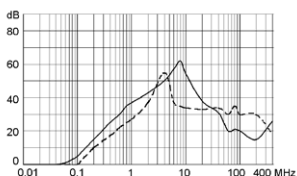
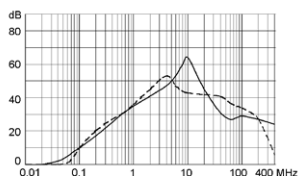

**All Variants**

Rated Current [A]	Rated Voltage [VAC]	Leakage Current [mA] @ 440V,	L [mH]	Cx [μF]	Cy [nF]	Weight [kg]	Housing	Order Number
3	275/480	0.5	1	0.1	4.7	0.2 kg	47	FMW-65-0001
6	275/480	0.5	0.5	0.1	4.7	0.2 kg	47	FMW-65-0002
10	275/480	0.5	0.4	0.1	4.7	0.23 kg	47	FMW-65-0003
10	275/480	3	0.4	0.1	22	0.35 kg	47	FMW-65-0004
20	275/480	3	0.15	0.1	22	0.25 kg	47	FMW-65-0005

Availability for all products can be searched real-time: <https://www.schurter.com/en/info-center/support-tools/stock-check-distributors>

1) Leakage current according IEC 60939-1

**Packaging unit**

10 Pcs