

IEC Appliance Inlet C8, Screw-on Mounting, Front Side, Solder or Quick-connect or Print Terminal



See below:
[Approvals and Compliances](#)

Description

- Panel mount :
 Screw-on mounting , front side
- Appliance Inlet , Pin temperature 70 °C , Protection class II
- Solder / Quick Connect / PCB Terminal
- Solder terminals in horizontal or vertical orientation

Characteristics

- Contact pins are turned from solid material

References

Last order date: 30.03.2025
 Last delivery date: 30.06.2025

Weblinks

[pdf data sheet](#), [html datasheet](#), [General Product Information](#), [Approvals](#), [Distributor-Stock-Check](#), [Accessories](#), [Detailed request for product](#)

Technical Data

Ratings IEC	2.5 A / 250 VAC; 50 Hz	Appliance inlet/-outlet	C8 acc. to IEC/EN 60320-1
Ratings UL/CSA	7 A / 125 VAC; 60 Hz		UL 60320-1, CSA C22.2 no. 60320-1
Dielectric Strength	> 3 kVAC between L-N > 1.5 kVAC between L/N-PE (1 min/50 Hz)		(for cold conditions) pin-temperature 70 °C, 2.5 A, Protection Class II
Allowable Operation Temperature	-25 °C to 70 °C		
IP-Protection	front side IP20 acc. to IEC 60529		
Protection against electric shock	Suitable for appliances with protection class II acc. to IEC 61140		
Material: Housing	PA6, black / grey / white, UL 94V-0		

Approvals and Compliances

Detailed information on product approvals, code requirements, usage instructions and detailed test conditions can be looked up in [Details about Approvals](#)

SCHURTER products are designed for use in industrial environments. They have approvals from independent testing bodies according to national and international standards. Products with specific characteristics and requirements such as required in the automotive sector according to IATF 16949, medical technology according to ISO 13485 or in the aerospace industry can be offered exclusively with customer-specific, individual agreements by SCHURTER.

Approvals



The approval mark is used by the testing authorities to certify compliance with the safety requirements placed on electronic products.

Approval Reference Type: 2571

Approval Logo	Certificates	Certification Body	Description
	VDE Approvals	VDE	VDE Certificate Number: 40034368
	UL Approvals	UL	UR File Number: E96454
	CSA Approvals	CSA	CSA Certification Record: 27324

Product standards

Product standards that are referenced

Organization	Design	Standard	Description
	Designed according to	IEC/EN 60320-1	Appliance couplers for household and similar general purposes
	Designed according to	UL 60320-1	Standard for Attachment Plugs and Receptacles
	Designed according to	CSA C22.2 no. 60320-1	General Use Receptacles, Attachment Plugs, and Similar Wiring Devices





Application standards

Application standards where the product can be used

Organization	Design	Standard	Description
	Suitable for applications acc.	IEC/UL 62368-1	Audio/video, information and communication technology equipment - Part 1: Safety requirements

Compliances

The product complies with following Guide Lines

Identification	Details	Initiator	Description
	CE declaration of conformity	SCHURTER AG	The CE marking declares that the product complies with the applicable requirements laid down in the harmonisation of Community legislation on its affixing in accordance with EU Regulation 765/2008.
	UKCA declaration of conformity	SCHURTER AG	The UKCA marking declares that the product complies with the applicable requirements laid down in the British Amendment of Regulation (EC) 765/2008.
	RoHS	SCHURTER AG	Directive RoHS 2011/65/EU, Amendment (EU) 2015/863
	China RoHS	SCHURTER AG	The law SJ / T 11363-2006 (China RoHS) has been in force since 1 March 2007. It is similar to the EU directive RoHS.
	REACH	SCHURTER AG	On 1 June 2007, Regulation (EC) No 1907/2006 on the Registration, Evaluation, Authorization and Restriction of Chemicals 1 (abbreviated as "REACH") entered into force.

Dimensions [mm]

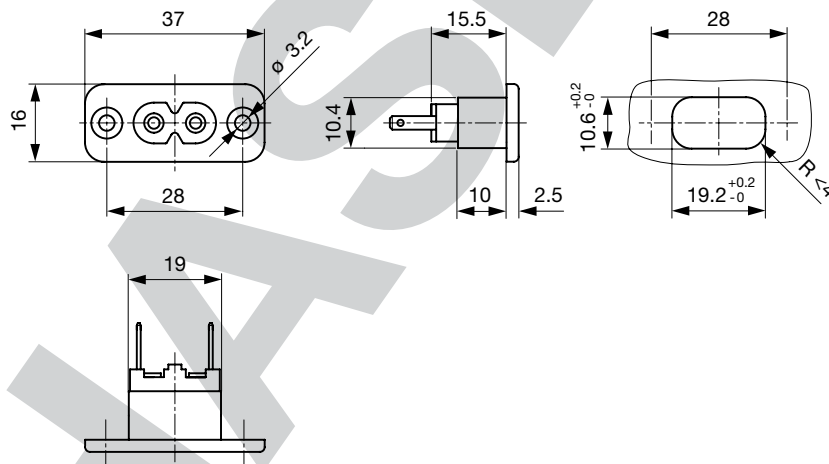

Length of the terminal please find at the order code configuration table

Config. Code









2571 - H - ABC0 - D - EGF

The characters are placeholders for the correspondingly keys of selections from the key tables.

2571 - **H** - ABC0 - D - EGF = Type

2571 - H - **A** BC0 - D - EGF = Terminals

Type	Configuration key
protection class II	X

Terminal L		Configuration key
short solder terminal (L = 4.8 mm)		2
long solder terminal (L = 8.5 mm)		3
PCB-terminal short (additional solder terminal)		5
PCB-terminal long (additional solder terminal)		6
Blade terminal (2.8 x 0.8 mm)		7
PCB-terminal (standard)		A
PCB-terminal (short)		B
PCB-terminal (long)		C

2571 - H - A B C 0 - D - E G F = Terminals

Terminal N	Configuration key
short solder terminal (L = 4.8 mm)	2
long solder terminal (L = 8.5 mm)	3
PCB-terminal short (additional solder terminal)	5
PCB-terminal long (additional solder terminal)	6
Blade terminal (2.8 x 0.8 mm)	7
PCB-terminal (standard)	A
PCB-terminal (short)	B
PCB-terminal (long)	C

Symbols similar as in table A

2571 - H - A B C 0 - D - E G F = Terminals

Terminal Ground	Configuration key
without terminal	0

Symbols similar as in table A

2571 - H - A B C 0 - D - E G F = Color

Color	Configuration key
Black	A
Grey	B
White	D

2571 - H - A B C 0 - D - E G F = Style

Style	Configuration key
flange with countersunk holes	1
flange with through holes	2

2571 - H - A B C 0 - D - E G F = Dimension S

Dimension "S"	Configuration key
00	

The dimension "S" is displayed in (1/10 mm). This information is also valid for the order code

2571 - H - A B C 0 - D - E G F = Orientation of Terminals

Orientation of Terminals	Configuration key
horizontal	A
vertical	B

All Variants

Terminals L / N	Orientation of Terminals	Color	Style	Config. Code	Order Number
short solder terminal (L = 4.8 mm)	vertical	Black	flange with countersunk holes	2571-X-2200-A-100B	6160.0004
long solder terminal (L = 8.5 mm)	vertical	Black	flange with through holes	2571-X-3300-A-200B	6160.0006
Blade terminal (2.8 x 0.8 mm)	vertical	Black	flange with countersunk holes	2571-X-7700-A-100B	6160.0007

The listed variants should be available from stock. Other versions on request www.schurter.com/contact

Availability for all products can be searched real-time: <https://www.schurter.com/en/info-center/support-tools/stock-check-distributors>

Packaging unit 100 Pcs