

Multibox 63A, DIII



See below:

**Approvals and Compliances**

**Description**

- Glass fiber Polyester
- Difficult to burn
- Impact resistant

**Unique Selling Proposition**

- Modern, practical design
- On request flush-mounted cover with stainless steel plate
- Thanks to only 117mm installation depth and insulation material, the insulated building envelope is not weakened when installed in flush-mounting
- Suitable for minergie standard

**Characteristics**

- Bolt lock (4-kant with Slot)
- Protection 2-piece, transparent and sealable
- N-connector for TN-C to TN-S
- N-connector separating Piece self-opening when loosening the screw
- Combination possible
- Refined connection technology
- Mounting type surface / flush

**References**

Alternative: Direct installation in concrete or other rated current

**Weblinks**

[pdf data sheet](#), [html datasheet](#), [Detailed request for product](#), [Microsite](#)

**Customer Specific Solutions**

Whether surface or flush-mounted, with Multibox you always work with the same housings and fuse elements (60A) or switch-disconnectors (DIN00). The additional housings, which can be attached with one click, give you maximum flexibility with a minimum of effort.



Smart Meetering MULTIBOX is up to the increased requirements. The energy meters of the latest generation of leading manufacturers fit perfectly into the housing the MULTIBOX. This is how the power distributors see the power supply and the energy measurement centrally at the point of entry into the building at a glance.



Fiber to the Home MULTIBOX introduces new technologies optimally and space-saving into the building. It takes on the role of the Building Entry Point (BEP). The flexible concept of MULTIBOX takes both a combined power cable with Speed Pipes as well as a separate fiber optic cable to the building.



MULTIBOX UPB The MULTIBOX UPB can be set in concrete directly with the simplest means. The UPB version is mounted on the formwork in a few easy steps and adjusted to the wall thickness with the wing screws.



MULTIBOX UPB After the pipes have been installed, the MULTIBOX can be set in concrete. As soon as the formwork is stripped, the polystyrene block is removed and the safety elements are installed and connected. The front frame and the cover form the end.

**Technical Data**

Rated Current Ie	63A @ 500VAC
Rated voltage Ue	500VAC
Rated isolation voltage Ui	1000VAC
Rated Power Operating Frequency fe	50Hz

Rated Impulse Withstand Voltage Uimp	6kV
Conditioned Rated Short Circuit Current	50kA @ 500VAC
Rated short-time withstand current with fuse links	20kA @ 500VAC
Allowed Ambient Temperature	-25°C to +40°C acc. to IEC 61439
Protection by closed housing	IP54

**Terminals**



Element with Double Straps	6 - 50mm <sup>2</sup>
Neutral Disconnecter with Double Straps	6 - 50mm <sup>2</sup>

Earth Connection Bride	6 - 50mm <sup>2</sup>
Double terminal	6 - 50mm <sup>2</sup>
Earth Connection	6 - 50mm <sup>2</sup>
Earth Connection (outside)	M8

Detailed information on product approvals, code requirements, usage instructions and detailed test conditions can be looked up in [Details about Approvals](#)

## Compliances

The product complies with following Guide Lines

Identification	Details	Initiator	Description
	<a href="#">CE declaration of conformity</a>	SCHURTER AG	The CE marking declares that the product complies with the applicable requirements laid down in the harmonisation of Community legislation on its affixing in accordance with EU Regulation 765/2008.
	<a href="#">UKCA declaration of conformity</a>	SCHURTER AG	The UKCA marking declares that the product complies with the applicable requirements laid down in the British Amendment of Regulation (EC) 765/2008.
	<a href="#">REACH</a>	SCHURTER AG	On 1 June 2007, Regulation (EC) No 1907/2006 on the Registration, Evaluation, Authorization and Restriction of Chemicals 1 (abbreviated as "REACH") entered into force.

## Assembly Instructions

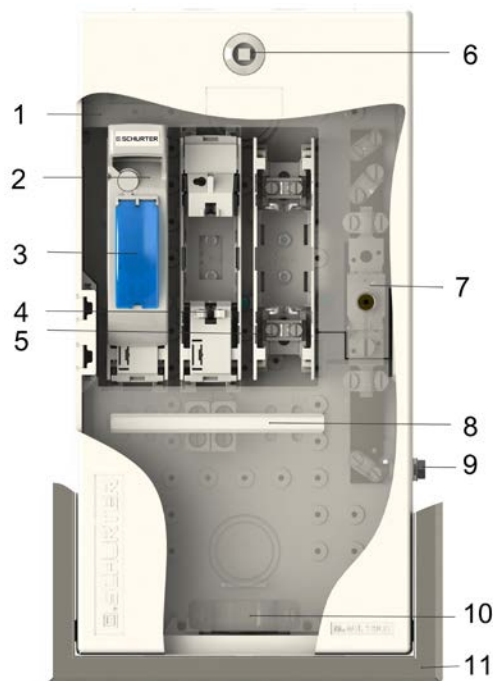

1. Cover Plate 2-piece, transparent and lockeable
2. NH-NH fuse load-breaker
3. Hinged window
4. Inner Cover
5. Various connection variants-clamp-Cable lug-Double terminals
6. Square lock
7. Neutral conductor isolator for TN-S/TN-C
8. Labeling field
9. External ground connection (optional)
10. Cable fixing (optional)
11. Front frame for UP mounting



12. 63A- Fuse element with different connection variants

Diagrams

TN-S (delivered condition)

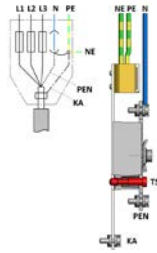

L = Pole conductor  
PE = Protective conductor  
PEN = PEN conductor  
N = Neutral conductor  
NE = Neutral earth conductor  
TS = Separating screw  
KA = Cable armor

TN-C

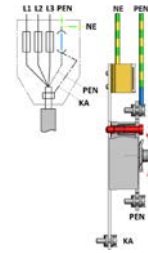

L = Pole conductor  
PE = Protective conductor  
PEN = PEN conductor  
N = Neutral conductor  
NE = Neutral earth conductor  
TS = Separating screw  
KA = Cable armor

## Order number key

### Accessories



### Cover No 1-9

A = undrilled	AD = 1x Ø 35 mm + 1x Ø 16mm
C = 2x stepped (compl.)	P = 2x Ø 35mm
D = 1x M40	Q = 1x Ø 50mm
E = 1x M50	R = 1x Ø 60mm
F = 1x M63	AE = 2x Ø 60mm
G = 2x M40	S = 1x Ø 55mm
H = 2x M50	T = 1x stepped (compl.)
J = 2x M63	V = 1x square
K = 1x M40 + 1x M16	X = 1x M16
M = 1x M50 + 1x M25	Y = 2x M25
N = 1x M63 + 1x M16	AB = 1x M25
O = 1x Ø 35mm	AA = 5x M25



### Cable fixation with clamp and rubber No 10-13

A = without cable fixation
B = single clamp Ø 42mm
C = single clamp Ø 24mm
D = double clamp Ø 42mm
E = double clamp Ø 24mm



### Lock No 14-18

C = with EMKA-Lock
D = with KABA-Lock
E = with 4-Kant 8x8 and slot



### DIN-Rail / Monting panel No 19-22

A = without DIN-Rail / Monting panel
B = with DIN-Rail
C = with Mounting panel



### Front frame

1/1	0011.0901
Combi 1+ 2	0011.0903
Combi 3 + 4	0011.0904
Combi 7	0011.0905

### Styrofoamblock

1/1	0011.9817
Combi 1+ 2	0011.9818
Combi 3 + 4	0011.9819

**Mounting type**

- 1= AP/ Surface-mounted without external earth
- 2= UP/ Flush-mounted without external earth, with building cover

**Neutral disconnecter**

- 1= 160 A/ TN-S/ TN-C

**Current**

- 1= 63 A
- 2= 160 A

**Connection type of the element DIII / DIN0**

- 63 A
- 1= Inlet double strap / outlet double strap
  - 2= Inlet double terminal / outlet double strap
- 160 A
- 3= Inlet terminal 70mm<sup>2</sup> / outlet terminal 70mm<sup>2</sup>
  - 4= Inlet screw / outlet terminal 70mm<sup>2</sup>
  - 5= Inlet screw / outlet screw
  - 6= Inlet double terminal / outlet terminal 70mm<sup>2</sup>

**Accessories**

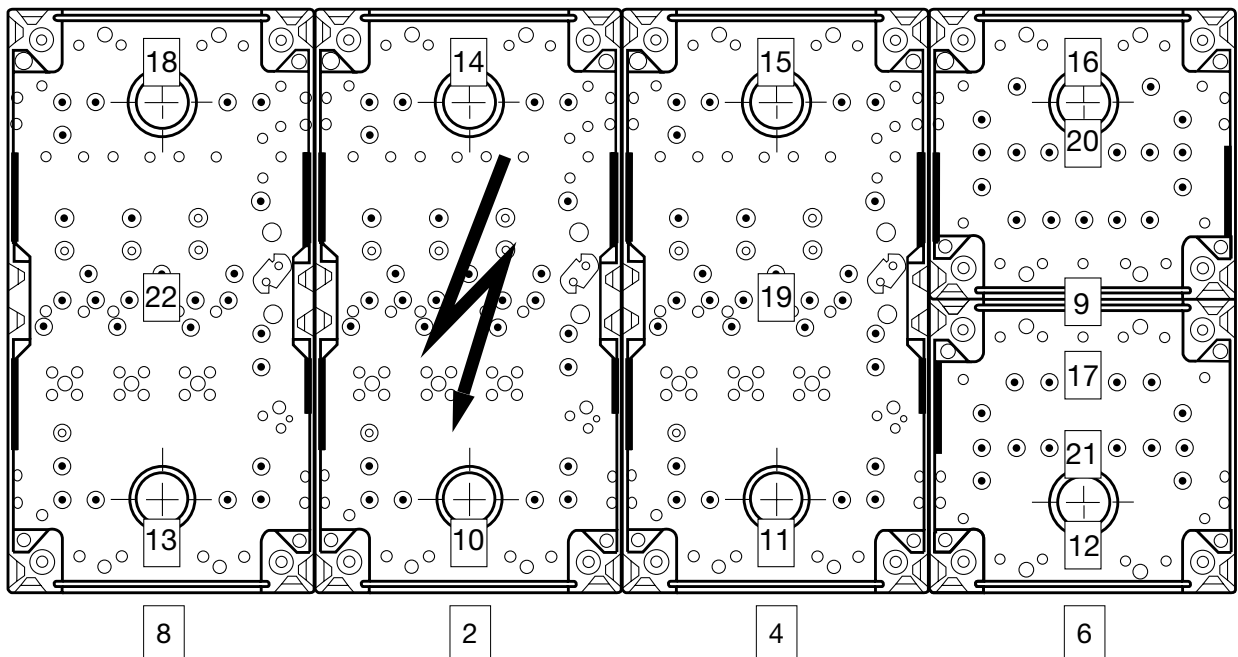
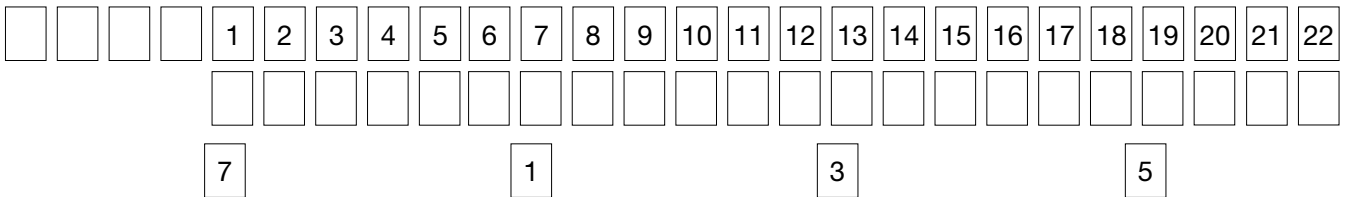

Andere Kombinationen sind möglich. Teilen Sie uns bitte Ihren Wunsch mit. Wir beraten Sie gerne.  
 Ausführung mit Hochleistungsautomaten auf Anfrage.

### Mounting type

1= AP/ Surface-mounted without external earth  
 2= UP/ Flush-mounted without external earth, with building cover

### Neutral disconnecter

1= 160 A/ TN-S/ TN-C

### Current

1= 63 A  
 2= 160 A

### Connection type of the element DIII / DIN0

63 A  
 1= Inlet double strap / outlet double strap  
 2= Inlet double terminal / outlet double strap

160 A  
 3= Inlet terminal 70mm<sup>2</sup> / outlet terminal 70mm<sup>2</sup>  
 4= Inlet screw / outlet terminal 70mm<sup>2</sup>  
 5= Inlet screw / outlet screw  
 6= Inlet double terminal / outlet terminal 70mm<sup>2</sup>

### Accessories

<input type="checkbox"/>	<input type="checkbox"/>	<input type="checkbox"/>	<input type="checkbox"/>	<input type="checkbox"/>	1	2	3	4	5	6	7	8	9	10	11	12	13	14	15	16	17	18	19	20	21
<input type="checkbox"/>	<input type="checkbox"/>	<input type="checkbox"/>	<input type="checkbox"/>	<input type="checkbox"/>	<input type="checkbox"/>	<input type="checkbox"/>	<input type="checkbox"/>	<input type="checkbox"/>	<input type="checkbox"/>	<input type="checkbox"/>	<input type="checkbox"/>	X	X	<input type="checkbox"/>	<input type="checkbox"/>	<input type="checkbox"/>	X	<input type="checkbox"/>	<input type="checkbox"/>	<input type="checkbox"/>	<input type="checkbox"/>	X	<input type="checkbox"/>	<input type="checkbox"/>	<input type="checkbox"/>

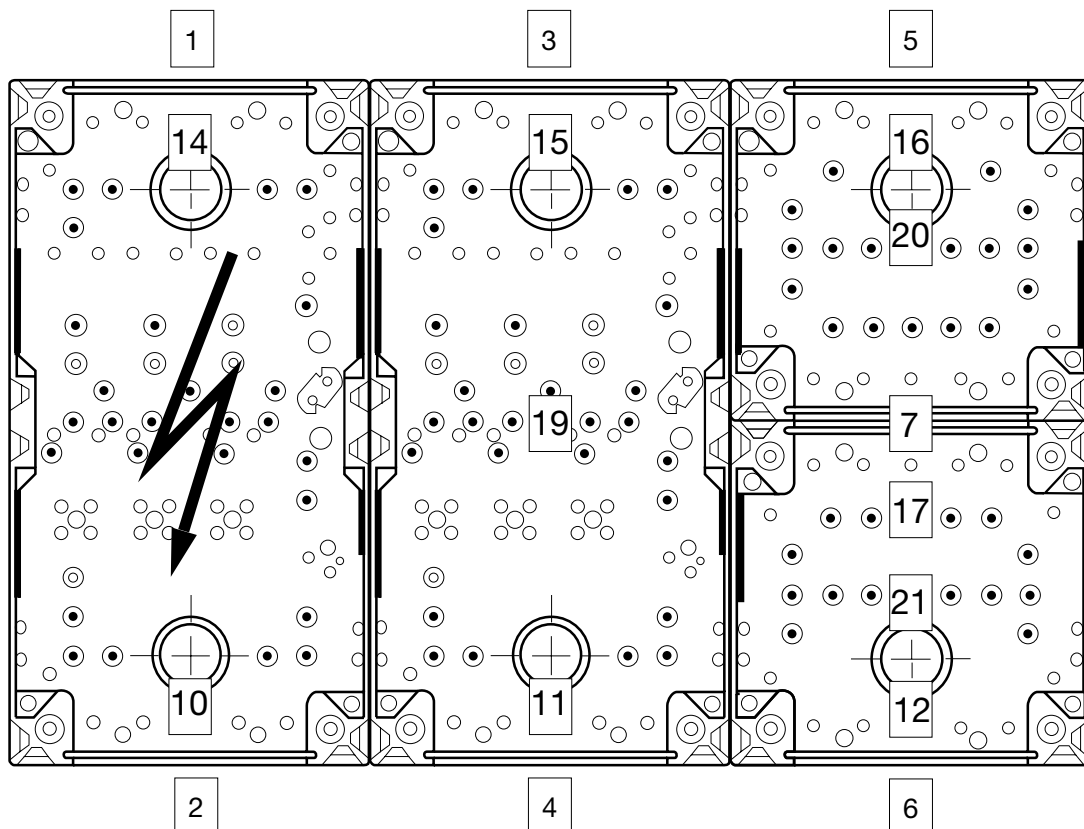

**Mounting type**

1= AP/ Surface-mounted without external earth  
 2= UP/ Flush-mounted without external earth, with building cover

**Neutral disconnecter**

1= 160 A/ TN-S/ TN-C

**Current**

1= 63 A  
 2= 160 A

**Connection type of the element DIII / DIN0**

63 A  
 1= Inlet double strap / outlet double strap  
 2= Inlet double terminal / outlet double strap  
  
 160 A  
 3= Inlet terminal 70mm<sup>2</sup> / outlet terminal 70mm<sup>2</sup>  
 4= Inlet screw / outlet terminal 70mm<sup>2</sup>  
 5= Inlet screw / outlet screw  
 6= Inlet double terminal / outlet terminal 70mm<sup>2</sup>

**Accessories**

<input type="checkbox"/>	<input type="checkbox"/>	<input type="checkbox"/>	<input type="checkbox"/>	<input type="checkbox"/>	1	2	3	4	5	6	7	8	9	10	11	12	13	14	15	16	17	18	19	20
											X	X	X				X				X	X		

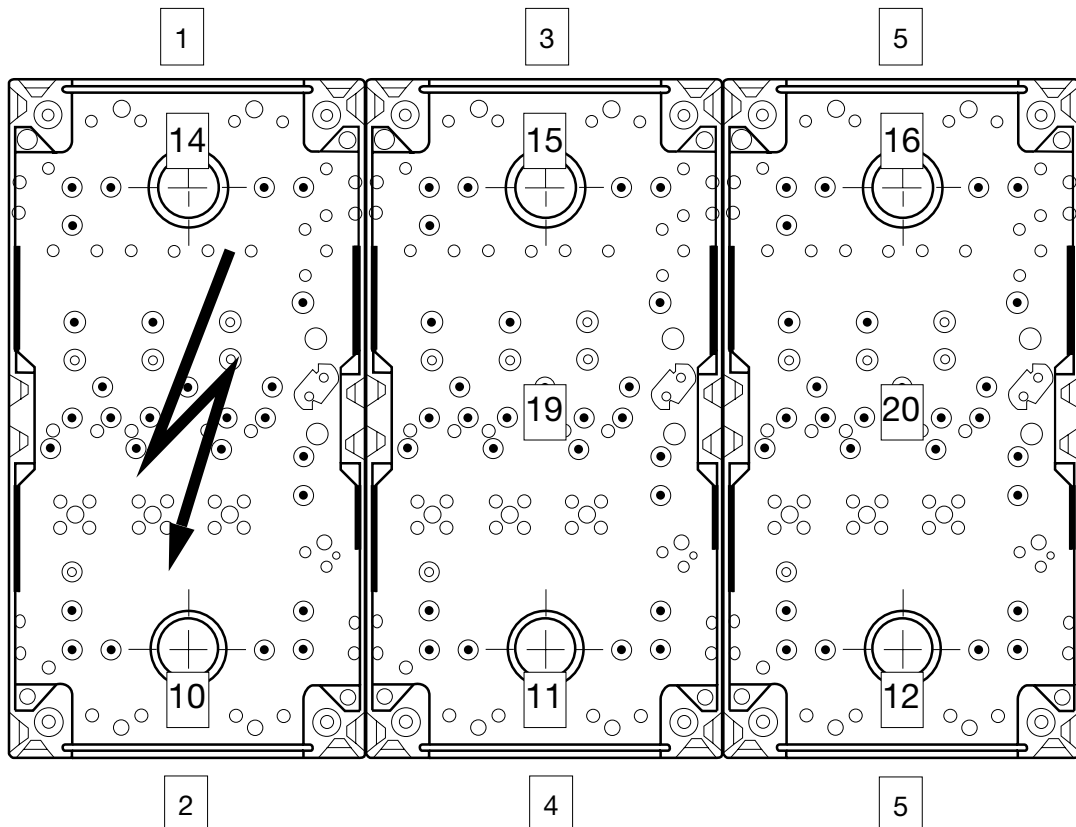

### Mounting type

- 1= AP/ Surface-mounted without external earth
- 2= UP/ Flush-mounted without external earth, with building cover

### Neutral disconnecter

- 1= 160 A/ TN-S/ TN-C

### Current

- 1= 63 A
- 2= 160 A

### Connection type of the element DIII / DIN0

- 63 A**
- 1= Inlet double strap / outlet double strap
  - 2= Inlet double terminal / outlet double strap
- 160 A**
- 3= Inlet terminal 70mm<sup>2</sup> / outlet terminal 70mm<sup>2</sup>
  - 4= Inlet screw / outlet terminal 70mm<sup>2</sup>
  - 5= Inlet screw / outlet screw
  - 6= Inlet double terminal / outlet terminal 70mm<sup>2</sup>

### Accessories

<input type="checkbox"/>	<input type="checkbox"/>	<input type="checkbox"/>	<input type="checkbox"/>	1	2	3	4	5	6	7	8	9	10	11	12	13	14	15	16	17	18	19	20
<input type="checkbox"/>	<input type="checkbox"/>	<input type="checkbox"/>	<input type="checkbox"/>	<input type="checkbox"/>	<input type="checkbox"/>	<input type="checkbox"/>	<input type="checkbox"/>	<input checked="" type="checkbox"/>	<input checked="" type="checkbox"/>	<input checked="" type="checkbox"/>	<input checked="" type="checkbox"/>	<input type="checkbox"/>	<input type="checkbox"/>	<input type="checkbox"/>	<input checked="" type="checkbox"/>	<input checked="" type="checkbox"/>	<input type="checkbox"/>	<input type="checkbox"/>	<input type="checkbox"/>	<input checked="" type="checkbox"/>	<input checked="" type="checkbox"/>	<input type="checkbox"/>	<input type="checkbox"/>

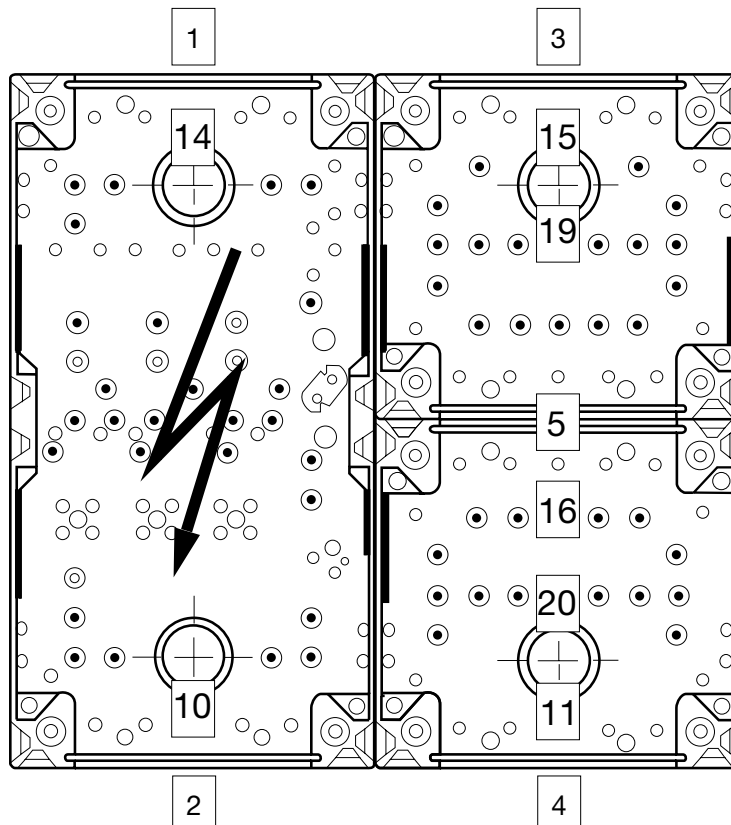



**Mounting type**

1= AP/ Surface-mounted without external earth  
 2= UP/ Flush-mounted without external earth, with building cover

**Neutral disconnecter**

1= 160 A/ TN-S/ TN-C

**Current**

1= 63 A  
 2= 160 A

**Connection type of the element DIII / DIN0**

63 A  
 1= Inlet double strap / outlet double strap  
 2= Inlet double terminal / outlet double strap

160 A  
 3= Inlet terminal 70mm<sup>2</sup> / outlet terminal 70mm<sup>2</sup>  
 4= Inlet screw / outlet terminal 70mm<sup>2</sup>  
 5= Inlet screw / outlet screw  
 6= Inlet double terminal / outlet terminal 70mm<sup>2</sup>

**Accessories**

<input type="checkbox"/>	<input type="checkbox"/>	<input type="checkbox"/>	<input type="checkbox"/>	<input type="checkbox"/>	1	2	3	4	5	6	7	8	9	10	11	12	13	14	15	16	17	18	19
<input type="checkbox"/>	<input type="checkbox"/>	<input type="checkbox"/>	<input type="checkbox"/>	<input type="checkbox"/>	<input type="checkbox"/>	<input type="checkbox"/>	<input type="checkbox"/>	<input type="checkbox"/>	X	X	X	X	X	<input type="checkbox"/>	<input type="checkbox"/>	X	X	<input type="checkbox"/>	<input type="checkbox"/>	X	X	X	<input type="checkbox"/>

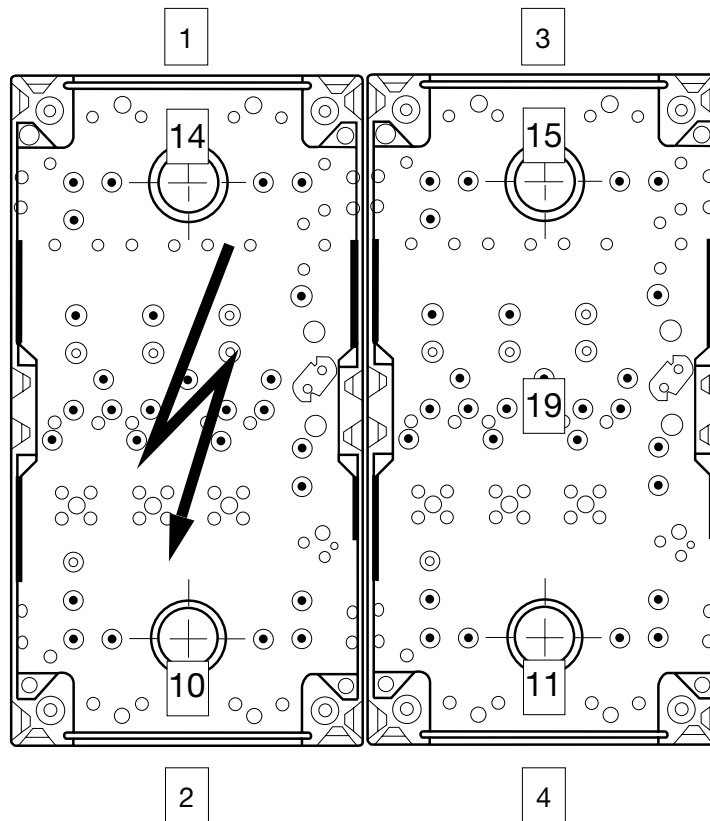

**Mounting type**

- 1= AP/ Surface-mounted with external earth
- 2= AP/ Surface-mounted without external earth
- 3= UP/ Flush-mounted without external earth, with building cover

**Connection of the screw element and neutral disconnecter**

- 63 A
- 1= Inlet double strap / outlet double strap
- 2= Inlet double terminal / outlet double strap

**Neutral disconnecter**

- 1= 160 A/ TN-S/ TN-C

**Accessories**

			1	2	3	4	5	6	7	8	9	10	11	12	13	14	15	16	17	18	19
					X	X	X	X	X	X	X		X	X	X		X	X	X	X	X

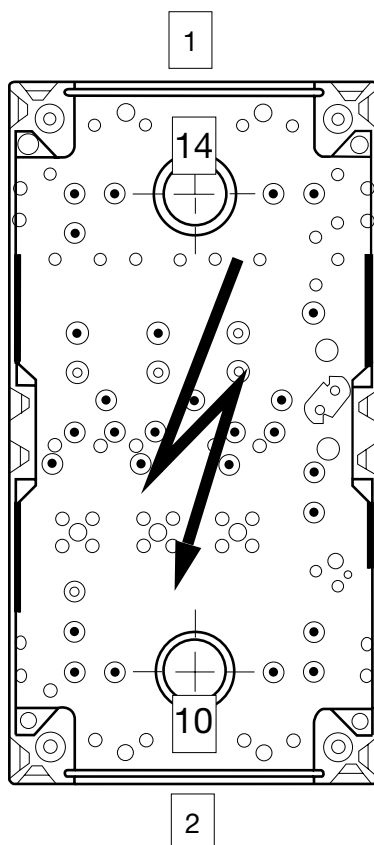

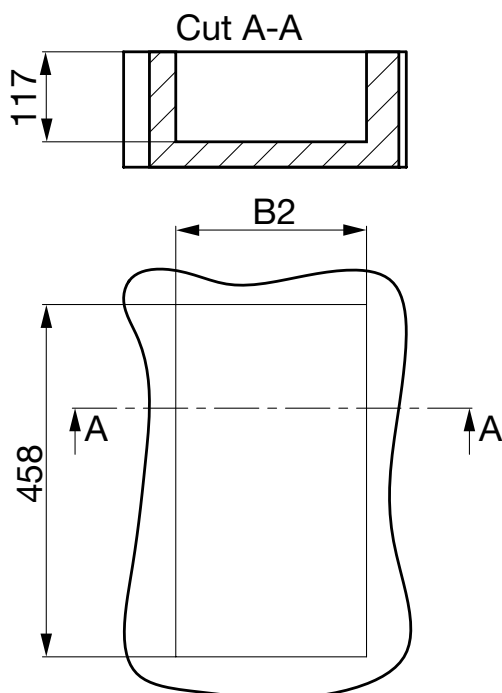
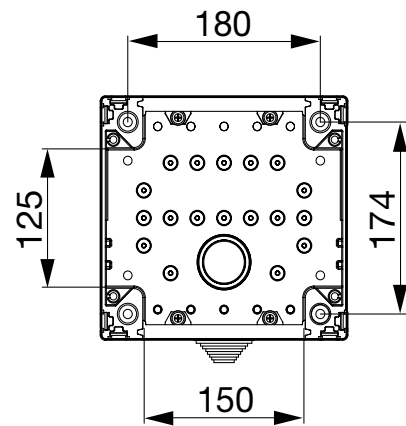
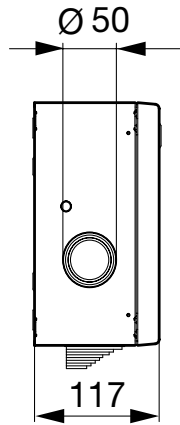
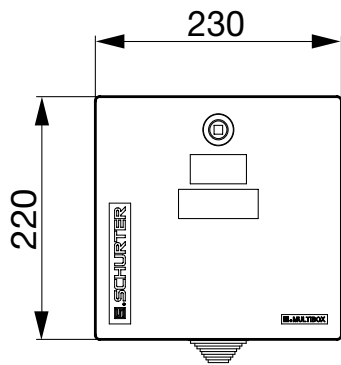
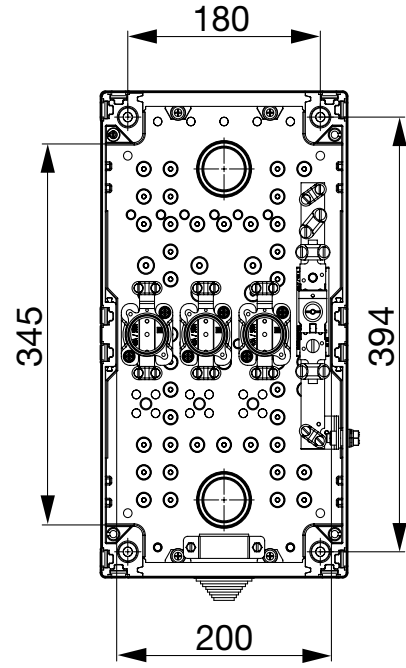
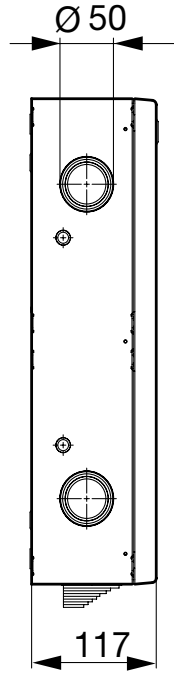
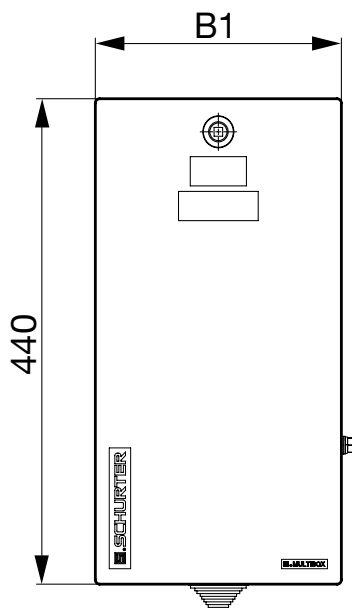

Version	B1	B2	Styrofoamblock
HAK	230	248	0011.9817
Combi 1+2	460	478	0011.9818
Combi 3+4	690	708	0011.9819
Combi 7	920	938	-

Installation with Styrofoamblock according table

## All Variants

Designation	Terminal	Order Number	E-No.
MULTIBOX AP HAK 63A DIII+0+E	Straps	0009.5161	111DDAA <sup>1)</sup>
MULTIBOX AP HAK 63A DW DIII+0+E	Double Terminal	0009.5163	121DDAA <sup>1)</sup>
MULTIBOX UP HAK 63A DIII+0	Straps	0009.5162	311QQBA <sup>1)</sup>
MULTIBOX UP HAK 63A DW DIII+0	Double Terminal	0009.5164	321QQBA <sup>1)</sup>

 Most Popular.

Availability for all products can be searched real-time: <https://www.schurter.com/en/Stock-Check/Stock-Check-SCHURTER>

<sup>1)</sup> E-Nr. corrisponde to ordercode

<b>Packaging unit</b>	1 Pcs
-----------------------	-------